

## Solid-State Memory Camcorder

### Operating Guide

Table of Contents	
Getting Started	
Recording	
Playback	
Editing	
Using the Menu	
Connecting with another device	
Troubleshooting	
Additional Information	

**XDCM™**

**XAVC**

**AVCHD**  
Progressive

**InfoLITHIUM V**  
SERIES

**MEMORY STICK™**

**SX**  
CLASS C

**HDMI™**  
HIGH DEFINITION MULTIMEDIA INTERFACE

**N™**

# Read this first

Before operating this unit, please read this manual thoroughly, and retain it for future reference.

## Notes on use

### Using the camcorder

- Do not hold the camcorder by the following parts, and also do not hold the camcorder by the jack covers.

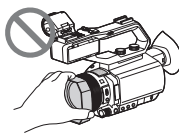

Lens hood

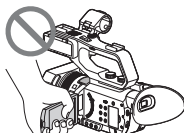

LCD screen

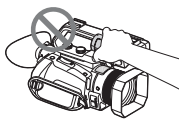

Microphone (sold separately) or  
Microphone holder

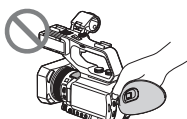

Viewfinder

### Notes

- The camcorder is not dustproof, dripproof or waterproof. See "About handling of your camcorder" (p. 122).
- When connecting the camcorder to another device with communication cables, be sure to insert the connector plug in the correct way. Pushing the plug forcibly into the terminal will damage the terminal and may result in a malfunction of the camcorder.
- Use the camcorder in accordance with the regulations of a place where you use it.

### On the LCD screen and lens

- A menu item that is grayed out is not available under the current recording or playback conditions.

- The LCD screen is manufactured using extremely high-precision technology, so over 99.99% of the pixels are operational for effective use. However, there may be some tiny black points and/or bright points (white, red, blue, or green in color) that appear constantly on the LCD screen. These points are normal results of the manufacturing process and do not affect the recording in any way.

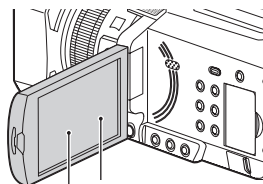

White, red, blue or green point  
Black point

### On sunlight

- Do not record the sun or leave the camcorder under the sun for a long time. The internal parts of the camcorder may be damaged. If sunlight is focused on a nearby object, it may cause a fire.
- Do not expose your camcorder's viewfinder, lens, or LCD screen to the sun or strong light source for extended periods. Doing so may cause a malfunction of the camcorder.
- Do not attempt to record the sun directly. Doing so may cause a malfunction of the camcorder.

### On the temperature of your camcorder and battery pack

Your camcorder has a protective function that disables recording or playback if the temperature of your camcorder or battery pack is beyond the safely operable range. In this case, a message appears on the LCD screen or in the viewfinder (p. 111).

## On recording

- In order to stabilize memory card operation, it is recommended that you format the memory card when you use it with your camcorder for the first time. All data recorded on the memory card will be erased by formatting, and cannot be recovered. Save important data on the memory card on other media such as a computer, before formatting the memory card.
- Before starting to record, test the recording function to make sure the picture and sound are recorded without any problems.
- Compensation for the loss of the content of recordings or the loss of recording opportunities cannot be provided, even if recording or playback is not possible due to a malfunction of the camcorder, storage media, etc., or even if images or sounds are distorted due to the limits of the capabilities of the camcorder.
- TV color systems differ depending on the countries/regions. To view your recordings on a TV, a TV of the appropriate color system for the country/region is required.
- Television programs, films, video tapes, and other materials may be copyrighted. Unauthorized recording of such materials may be contrary to the copyright laws.
- Because of the way that the image device (CMOS sensor) reads out image signals, the following phenomena may occur.
  - The subjects passing by the frame rapidly might appear crooked depending on the recording conditions. (This phenomenon may be notable in displays having high motion resolution.)
  - Horizontal lines appear on the LCD screen during recording under fluorescent lights, sodium lamps or mercury lamps. The phenomena can be reduced by adjusting the shutter speed (p. 40).

## Save all your recorded image data

- To prevent your image data from being lost, save all your recorded images on PC periodically.

## To handle the recorded images on your computer

Download the “Content Browser” software (p. 19).

## Format the recording media using [MEDIA FORMAT] if images are not recorded or played back properly

If you continue recording and deleting images on recording media for a long period of time, the files on that recording media may be fragmented. As a result, you may not be able to record and save images properly. If this happens, save images on a PC, then format the recording media (p. 78).

## About the operation of the camcorder

You can operate the camcorder using the **▲/▼/◀/▶/EXEC** buttons (p. 81), and the touch panel. However, you cannot use the touch panel\* to make some settings such as the MENU items.

\* Some operations are possible only with the touch panel.

## About this manual

- The on-screen displays in each local language are used for illustrating the operating procedures. Change the screen language before using your camcorder if necessary (p. 101).
- Design and specifications of recording media and other accessories are subject to change without notice.
- The value you can set in [REC FORMAT], etc., depends on the [60i/50i SEL.] setting. In this manual, the values for both [60i] and [50i] settings are described.

# Identifying parts and controls

## Body

The numbers in ( ) are reference pages.

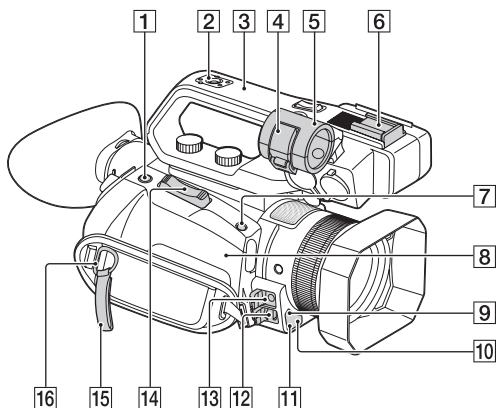

**1** ASSIGN4/FOCUS MAGNIFIER button (64)

**2** Accessory shoe receptacles

**3** XLR handle unit

**4** Microphone fixing clamper

**5** Microphone holder

**6** Accessory shoe

**7** ASSIGN5/IRIS PUSH AUTO button (39)

**8**  (N mark)

- Touch an NFC-enabled smartphone to the mark to establish a connection with the camcorder.
- Near Field Communication (NFC) is an international standard for short-range wireless communication technology.

**9** Remote sensor (101)

**10** Recording lamp (101)

**11** NIGHTSHOT light (48)

**12** Multi/Micro USB jack (102)  
VIDEO OUT jack (73, 90, 103)

**13** MIC jack (PLUG IN POWER)

**14** Power zoom lever

**15** Cable clamper

**16** Hook for shoulder strap

**17** Multi Interface Shoe (45)

### Attaching the XLR handle unit

- ① Remove the Multi Interface Shoe cap.

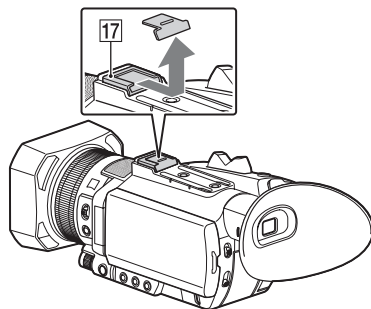



- ② Remove the handle shoe cap.

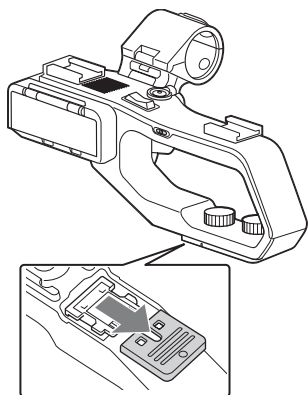

- ③ Align the mark on the XLR handle with the one on the camcorder, and insert the XLR handle unit in the direction of the arrow.

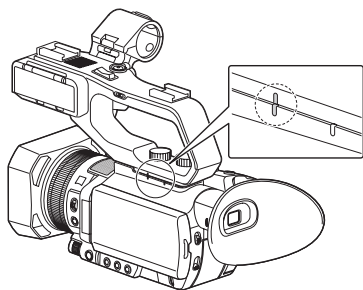
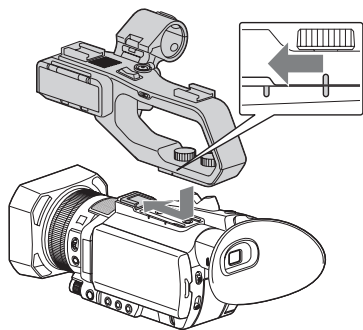

- ④ Press and turn the handle mounting screws to tighten them.

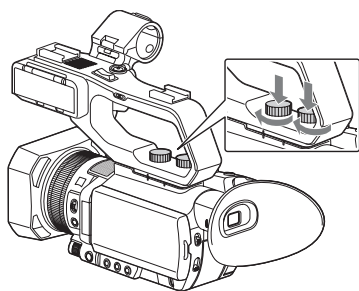

#### 💡 Tips

- When attaching the XLR handle unit, make sure to securely tighten both handle mounting screws.
- If you use the XLR handle unit without securely tightening the mounting screws, it may damage the Multi Interface Shoe or cause the camcorder to detach and fall.

#### Detaching the XLR handle unit

To detach the XLR handle unit, perform the attachment procedure in reverse.

#### Attaching the microphone (sold separately)

This section explains how to connect an external microphone (sold separately).

## Identifying parts and controls (Continued)

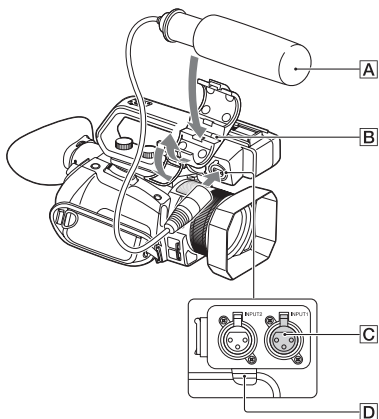

- ① Place the microphone **A** into the microphone holder **B**.
- ② Connect the plug of the microphone to the INPUT 1 jack **C**.
- ③ Place the microphone cable into the cable holder **D**.

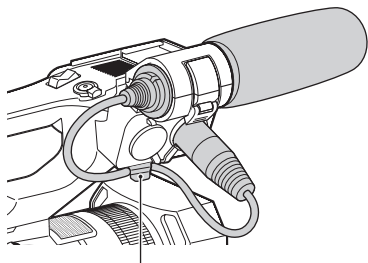

Put the cable in the outer cable holder.

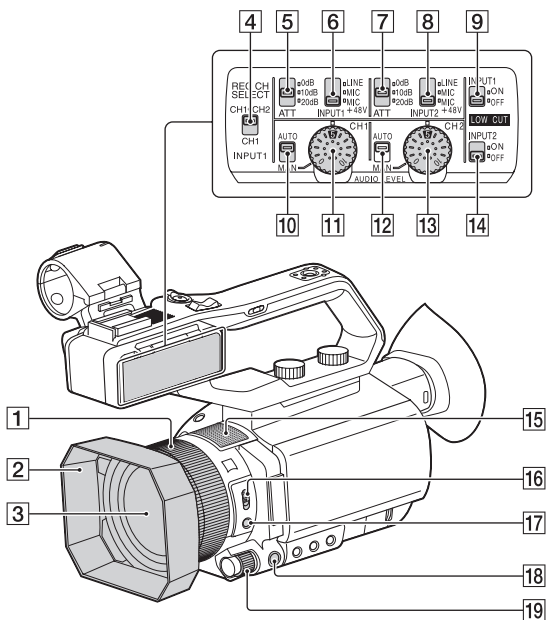

- 1** Manual lens ring (33)
- 2** Lens hood
- 3** Lens (ZEISS lens)
- 4** REC CH SELECT (INPUT1) switch (44)
- 5** ATT (INPUT1) switch (44)
- 6** INPUT1 (LINE/MIC/MIC+48V) switch (44)
- 7** ATT (INPUT2) switch (44)
- 8** INPUT2 (LINE/MIC/MIC+48V) switch (44)
- 9** LOW CUT (INPUT1) switch (44)
- 10** AUTO/MAN (CH1) switch (44)
- 11** AUDIO LEVEL (CH1) dial (44)
- 12** AUTO/MAN (CH2) switch (44)
- 13** AUDIO LEVEL (CH2) dial (44)
- 14** LOW CUT (INPUT2) switch (44)
- 15** Internal microphone
- 16** ZOOM/FOCUS switch (34)
- 17** AF/MF button (34)
- 18** MENU button (81)
- 19** MANUAL dial (39)

### Attaching the lens hood

Align the marks on the lens hood to those on the camcorder, and turn the lens hood in the direction of the arrow ② until it is locked.

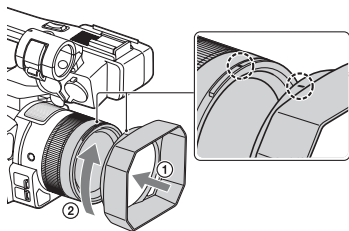

---

### 💡 Tips

- If you attach or remove a 62 mm (2 1/2 in.) PL filter or MC protector, remove the lens hood.

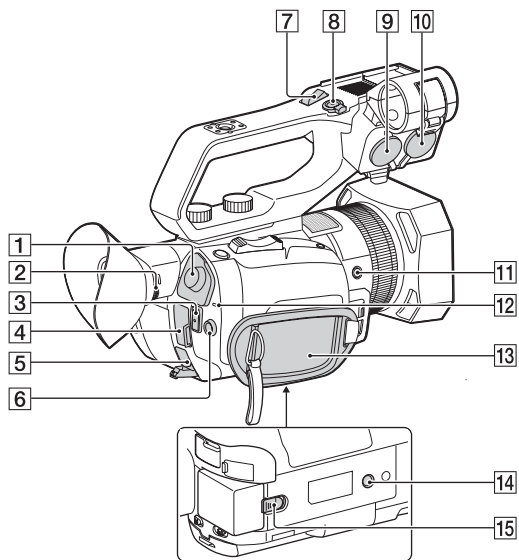

- 1** SDI OUT jack (73)
- 2** Lens adjustment dial (26)
- 3** START/STOP button (29)
- 4** HDMI OUT jack (73)
- 5** DC IN jack (21)
- 6** ▲/▼/◀/▶/EXEC button (81)
- 7** Handle zoom lever (33)
- 8** Handle record button (29)
- 9** INPUT2 jack (44)
- 10** INPUT1 jack (44)
- 11** ASSIGN6/D.EXTENDER button (64)
- 12** POWER/CHG lamp (21)
- 13** Grip belt
- 14** Tripod receptacles (1/4 inch)
- 15** BATT release lever (21)

For 1/4-20UNC screws

For attaching a tripod with a screw shorter than 5.5 mm (sold separately).

Some tripods may not be designed to attach in the proper direction.

## Identifying parts and controls (Continued)

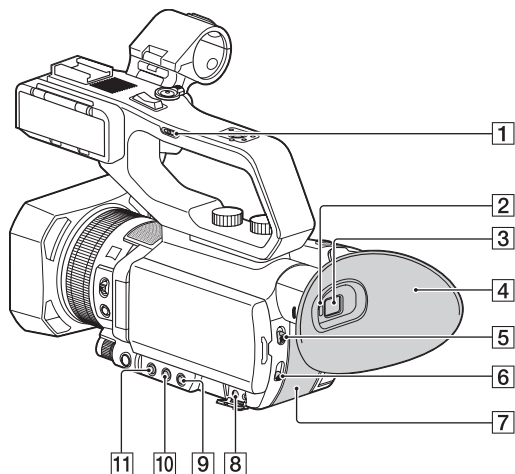

- 1** Handle zoom switch (33)
- 2** Eye sensor
- 3** Viewfinder (26)
- 4** Large eyecup (26)
- 5** AUTO/MANUAL switch (39)
- 6** ND FILTER switch (41)
- 7** Battery slot (21)
- 8**  (headphones) jack
- 9** SHUTTER SPEED button (40)
- 10** GAIN button (40)
- 11** IRIS button (39)

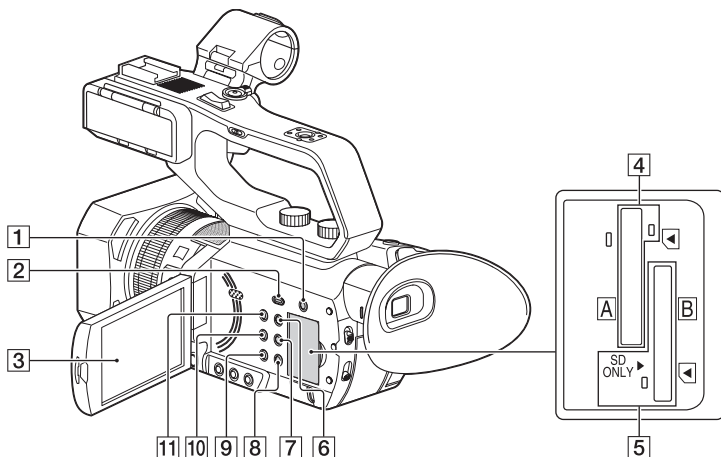

- 1** SLOT SELECT button (27)
- 2** THUMBNAIL button (66)
- 3** LCD screen/touch panel (26)
- 4** Memory card slot A/Memory card access lamp (27)
- 5** Memory card slot B/Memory card access lamp (27)
- 6** DISPLAY button (71)
- 7** ASSIGN3/PICTURE PROFILE button (64)
- 8** ASSIGN2/STATUS CHECK button (64)
- 9** ASSIGN1/LAST SCENE PREVIEW button (64)
- 10** WHT BAL button (42)
- 11**  (on/standby) button (24)

### Wireless Remote Commander

Remove the insulation sheet before using the Wireless Remote Commander.

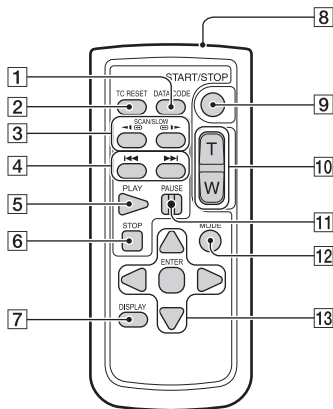
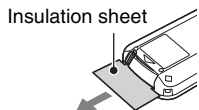

- 1 DATA CODE button (71)
- 2 TC RESET button (60)
- 3 SCAN/SLOW buttons (66)
- 4 ◀▶▶▶ (PREV/NEXT) buttons (66)
- 5 PLAY button (66)
- 6 STOP button (66)
- 7 DISPLAY button (71)
- 8 Transmitter
- 9 START/STOP button (29)
- 10 Power zoom lever
- 11 PAUSE button (66)
- 12 MODE button
- 13 ◀/▶/▲/▼/ENTER buttons

#### 🔊 Notes

- Aim the Wireless Remote Commander towards the remote sensor to operate your camcorder.

- Point the remote sensor away from strong light sources such as direct sunlight or overhead lighting. Otherwise, the Wireless Remote Commander may not function properly.
- When you are operating with the Wireless Remote Commander supplied with your camcorder, your video device may also operate. In that case, select a commander mode other than DVD2 for your video device, or cover the sensor of your video device with black paper.

### To change the battery of the Wireless Remote Commander

- ① While pressing on the tab, inset your fingernail into the slit to pull out the battery case.
- ② Place a new battery with the + side facing up.
- ③ Insert the battery case until it clicks into place.

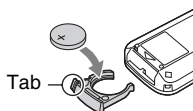

### WARNING

Battery may explode if mistreated. Do not recharge, disassemble or dispose of in fire.

- When the lithium battery becomes weak, the operating distance of the Wireless Remote Commander may shorten, or the Wireless Remote Commander may not function properly. In this case, replace the battery with a Sony CR2025 lithium battery. Use of another battery may present a risk of fire or explosion.



# Screen indicators

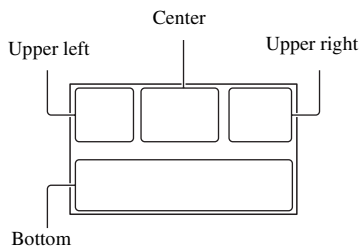

## Upper left

Indicator	Meaning
100%	Remaining battery
	INTELLIGENT AUTO (face detection/scene detection/camera-shake detection) (47)
	SCENE SELECTION (47)
	REC FORMAT (37)
	WIDE REC (90)
	Optical zoom
Z99  ×1.2	Clear image zoom
Z99  ×2.3	Digital zoom
	AIRPLANE MODE (99)
	SIMUL/RELAY REC
	NFC active
100-0001	Playback folder of memory card

## Center

Indicator	Meaning
	Vibration warning
	Recording media
REC STBY	Recording status (29)
	Warning (111)
	Playback indicator (66)
	Processing

Indicator	Meaning
	Relay recording
	SDI/HDMI REC CONTROL

## Upper right







Indicator	Meaning
Omin	Estimated remaining recording time
	Recording/playback media
00:00:00:00	Time code (hour:minute:second:frame)

## Bottom

Indicator	Meaning
	Face detection [ON]
PEAKING	PEAKING (94)
	ZEBRA (94)
	STEADY SHOT (88)
	Manual focus (34)
PP1 / PP6	Picture profile (53)
F5.6	Iris (39)
9dB	Gain (40)
100 180°	Shutter speed (40)
DolbyD	AVCHD AUDIO FORMAT (92)
-2.0EV	AE SHIFT (87)
A / B	Auto setting/manual setting (95)
	White balance (42)
	HISTOGRAM (93)



## Screen indicators (Continued)

Indicator	Meaning
	AUTO SLOW SHUTTER
	AUDIO LEVEL DISPLAY (95)
	D.EXTENDER (87)
	REC LEVEL MODE
	NIGHTSHOT
	SELECTED MIC
	ND filter (41)

### Tips

- Indicators may look different or appear at different positions.

### Data code during recording

The recording date, time and condition are recorded automatically on the recording media. They are not displayed while recording. However, you can check them by selecting  (DISPLAY SET) → [DATA CODE] and choosing the data that you want to display, or by pressing the ASSIGN button to which the DATA CODE function is assigned, during playback (p. 71).

# Table of Contents

Read this first .....	2
Identifying parts and controls .....	4
Body .....	4
Wireless Remote Commander .....	12
Screen indicators .....	13

## Getting Started

Step 1: Checking supplied accessories .....	19
Step 2: Charging the battery pack .....	21
Step 3: Attaching the accessory shoe .....	23
Step 4: Turning on the camcorder and setting the date and time .....	24
Setting the date and time .....	24
Step 5: Adjusting the LCD screen and viewfinder .....	26
Step 6: Preparing the recording media .....	27

## Recording

Recording .....	29
Recording movies .....	29
Changing the setting of the START/STOP button and handle record button .....	32
Adjusting the zoom .....	33
Adjusting the focus .....	34
Using the Focus magnifier .....	35
Focusing by touching the LCD screen (Spot focus).....	35
Focusing on a detected face (Face detection).....	35
Changing the recording setting .....	37
Selecting the file format and recording format.....	37
Setting the DV MODE (DV mode) .....	38
Adjusting the brightness .....	39
Adjusting the iris .....	39
Adjusting the gain .....	40
Adjusting the shutter speed.....	40
Adjusting the exposure .....	41
Adjusting the volume of light (ND filter) .....	41
Adjusting the color tone .....	42
Adjusting the white balance.....	42
Audio setup .....	43
Recording sound from the internal microphone .....	43
Recording sound from an external audio device.....	43
Recording sound from a Multi Interface Shoe compatible microphone (sold separately) .....	45

## Table of Contents (Continued)

Recording sound from an external microphone (sold separately).....	45
Adjusting the audio level from the INPUT1 and INPUT2 jacks .....	46
Adjusting the audio level from the internal microphone or an external microphone (PLUG IN POWER) .....	46
<b>Useful functions .....</b>	<b>47</b>
Selecting the suitable setting automatically for the recording situation (AUTO MODE setting) .....	47
Shooting in dark conditions (NIGHTSHOT).....	48
What you can do with the Wi-Fi function of the camcorder.....	48
Downloading “Content Browser Mobile” .....	48
Connecting the camcorder to an Android smartphone equipped with the NFC function using One-touch.....	49
Using a smartphone as a remote controller .....	50
Connecting without using the NFC function (Android).....	51
Connecting without using the NFC function (iPhone/iPad) .....	52
Customizing the picture quality (Picture profile) .....	53
Setting time data .....	60
Recording with the Slow & Quick Motion function .....	61
Reviewing the most recently recorded scene (Last Scene Review).....	63
<b>Assigning the functions to the ASSIGN buttons .....</b>	<b>64</b>









## Playback

<b>Playback .....</b>	<b>66</b>
Playing back movies .....	66
Playing back still images.....	69
<b>Changing/checking the settings in your camcorder .....</b>	<b>71</b>
Changing the screen display .....	71
Displaying recording data (Data code).....	71
Checking the settings in your camcorder (Status check).....	72
<b>Connecting a monitor or a TV .....</b>	<b>73</b>

## Editing

<b>Protecting movies and still images (Protect) .....</b>	<b>76</b>
<b>Dividing a movie .....</b>	<b>76</b>
<b>Deleting movies and still images .....</b>	<b>77</b>
<b>Formatting the recording media .....</b>	<b>78</b>
<b>Deleting all data from the memory card completely .....</b>	<b>79</b>
<b>Repairing the image database file .....</b>	<b>80</b>

## Using the Menu

Operating the menu .....	81
Menu items .....	83
 (CAMERA SET) menu .....	86
Settings to adjust your camcorder to the recording conditions (  STEADY SHOT, etc.)	
 (REC/OUT SET) menu .....	90
Recording settings, input and output settings (REC SET/VIDEO OUT, etc.)	
 (AUDIO SET) menu .....	92
Settings for the audio recording (AVCHD AUDIO FORMAT, etc.)	
 (DISPLAY SET) menu .....	93
Display settings (MARKER/DISPLAY OUTPUT, etc.)	
 (TC/UB SET) menu .....	97
Time code settings (TC PRESET/UB PRESET/TC FORMAT, etc.)	
 (NETWORK SET) menu .....	99
Settings for the Wi-Fi function (CTRL W/SMARTPHONE, etc.)	
 (OTHERS) menu .....	100
Settings while recording or other basic settings (AREA SET/BEEP, etc.)	

## Connecting with another device

Creating a standard definition image quality (SD) disc with a recorder, etc. .....	103
---	-----

## Troubleshooting

Troubleshooting .....	104
Warning indicators and messages .....	111

## Additional Information

Recording time of movies .....	114
Using your camcorder abroad .....	116
File/folder structure on the recording media .....	117
Maintenance and precautions .....	119
About the XAVC HD format .....	119
About the AVCHD format .....	119
About the memory card .....	119
About the "InfoLITHIUM" battery pack .....	120
About handling of your camcorder .....	122

## Table of Contents (Continued)

Specifications .....	125
Index .....	129

# Step 1: Checking supplied accessories

Make sure that you have following items supplied with your camcorder. The number in the parentheses indicates the number of that item supplied. Recording media are sold separately.

AC Adaptor (AC-L200D) (1) (p. 21)

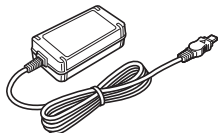

Power cord (mains lead) (1) (p. 21)

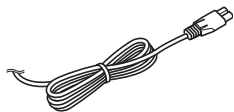

Wireless Remote Commander (RMT-845) (1) (p. 12)



A button-type lithium battery is already installed.

Large eyecup (1) (p. 26)



Lens hood (1) (p. 8)

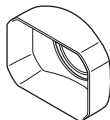

Lens cap (Attached to lens) (1)



Accessory shoe kit (Accessory shoe (1), Accessory shoe plate (1), screws (4)) (p. 23)

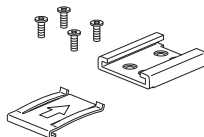

XLR handle unit (1)

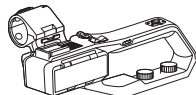

USB cable (1)

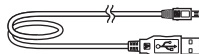

Rechargeable battery pack (NP-FV70) (1)

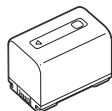

CD-ROM "Manuals for Solid-State Memory Camcorder" (1)

Operating Guide (2)

## Software Downloads

When the unit is used with a PC connection, download device drivers, plugins, and application software, where applicable, from the Sony Professional products web site.

Sony Professional products web site homepage:

U.S.A.	<a href="http://pro.sony.com">http://pro.sony.com</a>
Canada	<a href="http://www.sonybiz.ca">http://www.sonybiz.ca</a>
Latin America	<a href="http://sonypro-latin.com">http://sonypro-latin.com</a>
Europe, Middle East and Africa	<a href="http://www.pro.sony.eu">http://www.pro.sony.eu</a>
Japan	<a href="http://www.sonybsc.com">http://www.sonybsc.com</a>
Asia Pacific	<a href="http://pro.sony-asia.com">http://pro.sony-asia.com</a>

## Step 1: Checking supplied accessories (Continued)

Korea            <http://bp.sony.co.kr>  
China            <http://pro.sony.com.cn>

Although the data regarding recorded materials are stored over multiple files and folders, you can easily handle the clips without considering its data and directory structure, by using the dedicated application software.



## Step 2: Charging the battery pack

You can charge the “InfoLITHIUM” battery pack (V series) with the supplied AC Adaptor.

### Notes

- You can use a large capacity battery pack, NP-FV100 (sold separately), with your camcorder. You cannot use NP-FV50.

- 1 Close the LCD screen and store the viewfinder before attaching the battery.

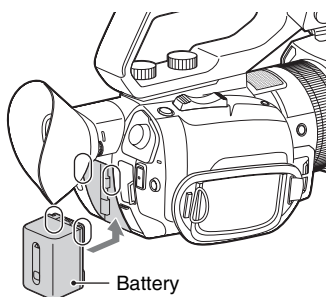

- 2 Connect the AC Adaptor and power cord from the camcorder to a outlet.

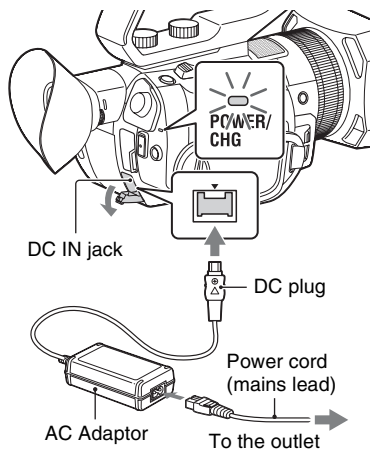

- The CHG lamp lights up and charging starts.
- The CHG lamp turns off when the battery is fully charged. Disconnect the AC Adaptor from the DC IN jack.

### Tips

- You can check the remaining battery life with the status check function (p. 72).

## Charging time

Approximate time (minute) required when you charge a fully discharged battery pack.

Battery pack	Full charge time
NP-FV70	205

## Using an outside power source

You can use the AC Adaptor to obtain the AC power. While you are using the AC Adaptor, the battery pack will not lose its charge even when it is attached to your camcorder.

Follow the procedure from 1 to 2 as shown in “Step 2: Charging the battery pack” on page 21.

## Step 2: Charging the battery pack (Continued)

### To remove the battery pack

Turn the power off, then slide the BATT release lever to release the battery.

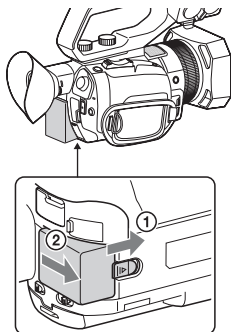

### On the battery pack

- Turn the power off before changing the battery pack.
- The CHG lamp flashes during charging, or the Battery Info (p. 72) will not be correctly displayed under the following conditions.
  - The battery pack is not attached correctly.
  - The battery pack is damaged.
  - The battery pack is worn-out.

### On the AC Adaptor

- Do not short-circuit the DC plug of the AC Adaptor or battery terminal with any metallic objects. This may cause a malfunction.

### To store the battery pack

If the battery pack is not in use for a while, run down the battery and store it (p. 121).

## Step 3: Attaching the accessory shoe

### To mount the accessory shoe

Mount the accessory shoe on the accessory shoe mount as illustrated.

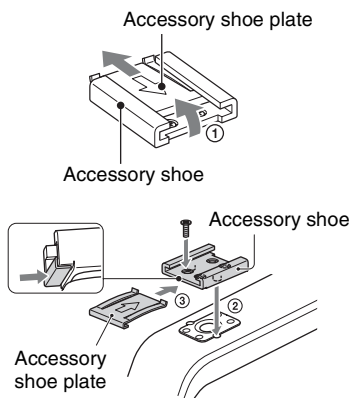

- ① Lift the edge of the accessory shoe plate and pull it in the direction opposite to that of the arrow on the accessory shoe plate and remove it from the accessory shoe.
- ② Place the accessory shoe as its protrusions matches recesses of the accessory shoe mount, then fix it to the mount with four screws.
- ③ Insert the accessory shoe plate in the direction of the arrow on the plate surface until the end of the plate engages the end of the shoe.

### To remove the accessory shoe

Remove the shoe plate in the same way as step ① of “To mount the accessory shoe.” Loosen the 4 screws and remove the accessory shoe from the accessory shoe mount.

# Step 4: Turning on the camcorder and setting the date and time

## Turning on the camcorder

Open the LCD screen and turn the power on.

You can also turn on the power by extending the viewfinder or by pressing the POWER button.

When you use your camcorder for the first time, the [CLOCK SET] screen appears.

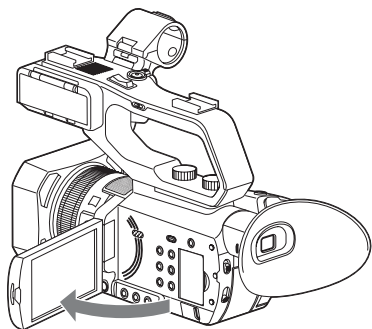

## To turn off the power

Close the LCD screen.

If the viewfinder is extended, return it to its original position.

You can also turn off the power by pressing the POWER button.

### Notes

- If warning messages appear on the LCD screen, follow the instructions.
- When recording movies or when connected to another device via USB, the camcorder does not turn off even if the LCD screen is closed and the viewfinder is returned to its original position.

## Setting the date and time

Set the date and time when you use your camcorder for the first time.

### Tips

- If you do not use your camcorder for **about 3 months**, the built-in rechargeable battery gets discharged and the date and time settings may be cleared from the memory. In that case, charge the rechargeable battery and then set the date and time again (p. 124).

### LCD screen

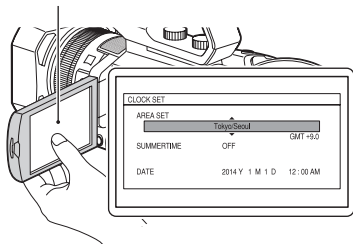



When you set the date and time again, press the MENU button, and select

 (OTHERS) → [CLOCK SET].

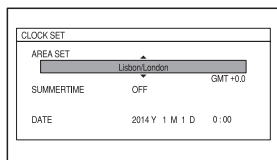
- 1 Select your area by pressing the //EXEC button, then press the button.



- 2 Set [SUMMERTIME], [Y] (year), [M] (month), [D] (day), hour and minute, by pressing the //EXEC button, then press the button.

CLOCK SET		
AREA SET	Lisbon/London	
SUMMERTIME	OFF	GMT +0.0
DATE	<input type="text" value="2007"/> Y 1 M 1 D 0 : 00	

The clock starts.

- Set [SUMMERTIME] to [ON] to move the time forward 1 hour.
- You can set any year up to the year 2037.
- Midnight is indicated as 12:00 AM, and noon as 12:00 PM (when [60i] is selected).

#### Tips

- The date and time are automatically recorded on the selected recording media, and can be displayed during playback (ASSIGN button to which [DATA CODE] is assigned, p. 71).

# Step 5: Adjusting the LCD screen and viewfinder

## Using the LCD screen

The LCD screen can be rotated in the range as illustrated below, allowing a person other than the camera operator to see the image.

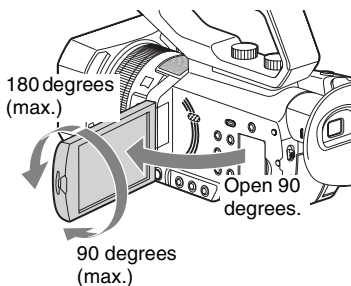

## Adjusting the viewfinder

When using the viewfinder, extend it and position your eye near it. If you extend the viewfinder while the LCD screen is open, the display switches from the LCD screen to the viewfinder when you position your eye near the viewfinder. If the viewfinder image appears blurred, turn the lens adjustment dial next to the viewfinder until the image is sharp.

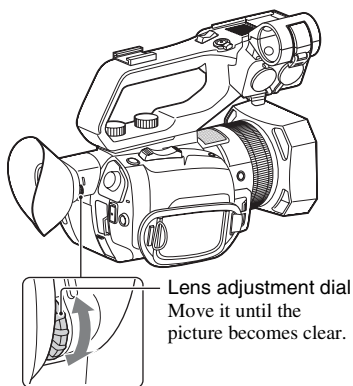

## When the picture in the viewfinder is hard to see

If you cannot see the picture in the viewfinder clearly under bright circumstances, use the supplied large eyecup. To attach the large eyecup, stretch it slightly and fit it over the groove of the eyecup attached to the camcorder. You can attach the large eyecup facing either the right or left side.

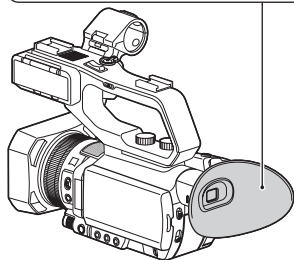
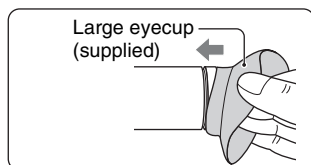

## Notes

- If the viewfinder is extended while the battery pack NP-FV100 (sold separately) is attached, the large eyecup and battery pack may interfere with each other slightly. However, this does not affect the functionality of the camcorder.

# Step 6: Preparing the recording media

## Types of memory cards you can use in your camcorder

File format	Types of media
AVCHD	SD, SDHC, SDXC memory card (Class 4 or faster), Memory Stick PRO Duo, PRO-HG Duo, XC-HG
DV	SD, SDHC, SDXC memory card (Class 6 or faster), Memory Stick PRO-HG Duo, XC-HG
XAVC HD	SDXC memory card (Class 10 or faster, UHS-I), Memory Stick XC-HG*1
S&Q (AVCHD)	SD, SDHC, SDXC memory card (Class 10 or faster)
S&Q (XAVC HD)	SDXC memory card (UHS-I U3 (UHS-I Speed Class 3))

\*1 Standard mode only

### Notes

- Operation with all memory cards is not assured.
- Only “Memory Stick PRO Duo” media, which is half the size of standard “Memory Stick” media, or “Memory Stick XC-HG Duo” media, or standard size SD cards can be used with this camcorder.
- See page 114 for the recordable time of memory cards.
- Movies recorded on “Memory Stick XC-HG Duo” media or SDXC memory cards can be imported to or played back on other equipment, such as a computer or A/V device, by connecting the camcorder to the equipment with the USB cable. However, the equipment must support the exFAT file system used for “Memory Stick XC-HG Duo” media and SDXC memory cards. Confirm in advance that the connecting equipment is supporting the exFAT file system. If you connect equipment not supporting the exFAT file system and the format screen appears, do not perform the format. All the data recorded will be lost.

Open the cover, and insert the memory card with the notched edge in the direction as illustrated until it clicks into place.

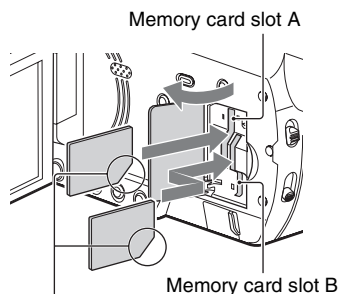

Note the direction of the notched corner.

- If you insert a memory card into the slot in the wrong direction, the memory card, the memory card slot, or image data may be damaged.
- Memory card slot A accepts either “Memory Stick PRO Duo” media or an SD card. Memory card slot B accepts an SD card only.

## To eject the memory card

Lightly push the memory card once.

### Notes

- If [The image database file is corrupted. The media must be restored to use again.] appears, format the memory card (p. 78).
- When inserting or ejecting the memory card, be careful of the memory card popping out and dropping.

## Step 6: Preparing the recording media (Continued)

### Selecting the memory card slot to be used for recording

Press the SLOT SELECT button to change which slot is selected for recording. You can confirm the selected slot on the screen.

SLOT SELECT button

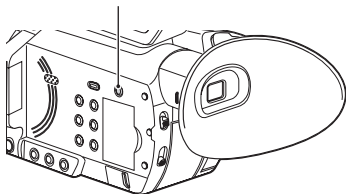

#### 🔔 Notes

- You can only select a slot that already has a memory card inserted.
- While movies are being recorded on the memory card, you cannot switch the slot even if you press the SLOT SELECT button.

#### 💡 Tips

- When only one slot has a memory card inserted, the slot that has the memory card is selected automatically.



# Recording

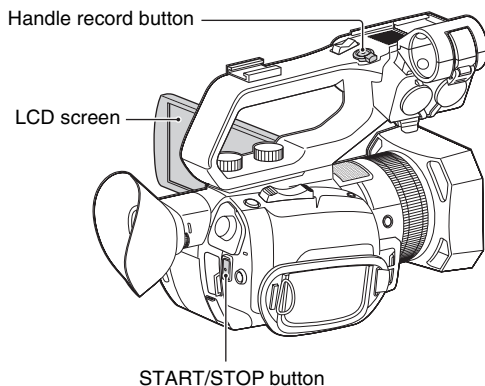

## Recording movies

Your camcorder records movies on a memory card. The factory setting of recording movies is XAVC HD. Do the following steps to record movies.

- 1** Press the latches on both sides of the lens cap and remove it.

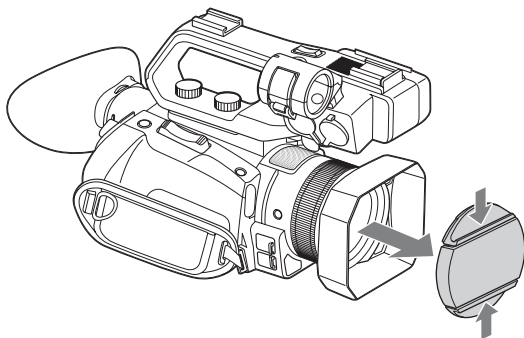

- 2** Open the LCD screen, and press the **START/STOP** button (or the handle record button) to start recording.

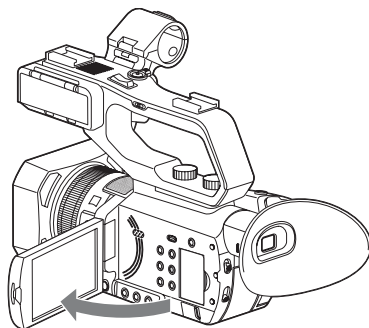

The recording lamps light up during recording.

To stop the movie recording, press the **START/STOP** button or the handle record button again.

---

### Notes

- When [AUTO] is selected in the [MIC SELECT] menu and the XLR handle unit is connected to the camcorder without a microphone attached to the INPUT1 and INPUT2 jacks, the internal microphone is not selected and no audio is recorded. In this case, select [INT MIC]. Refer to page 92.
- When the access lamp is lit or flashing in red, your camcorder is reading or writing data on recording media. Do not shake or apply strong force to your camcorder, do not turn the power off, and do not remove the recording media, battery pack or the AC Adaptor. The image data may be destroyed.
- See page 114 on the recording time of movies.
- If a movie file size exceeds 2 GB while recording in DV or AVCHD format, the camcorder automatically divides the file and creates a new one.
- The menu settings, picture profile settings, and settings made using the AUTO/MANUAL switch are saved when you close the LCD screen and turn off the camcorder. The POWER/CHG lamp flashes while the settings are being stored.

### Tips

- When recording at a setting other than DV, the aspect ratio is fixed to 16:9. When recording in DV mode, you can switch the aspect ratio to 4:3 ([**DV**] WIDE REC], p. 90).
- You can change the screen display during recording (p. 71).
- Indicators displayed on the LCD screen during recording are shown on page 13.
- The recording lamps can be set to stay off ([REC LAMP], p. 101).

## To continue recording on the memory cards, one after another (Relay recording)

Insert memory cards each in both slots A and B, so the camcorder switches memory card A (or B) just before space on the other one runs out, and continues recording on the next memory card automatically.

Do the following setting before recording.

Press MENU → Select  $\left[ \begin{smallmatrix} \text{REC} \\ \text{OUT SET} \end{smallmatrix} \right]$  → [REC SET] → [SIMUL/RELAY REC] → [RELAY REC] with the  $\blacktriangle/\blacktriangledown/\blacktriangleleft/\blacktriangleright$ /EXEC button.

Insert a recordable memory card.

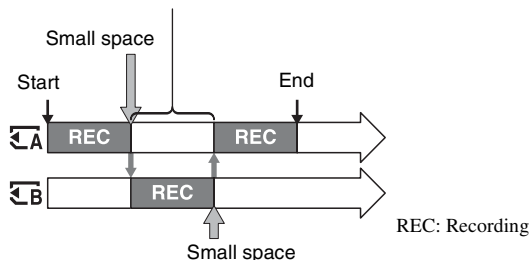

### Notes

- Do not eject the memory card that is currently being used for recording. When replacing a memory card while recording, replace only the one in the slot whose access lamp is off.
- Even if you press the SLOT SELECT button, while recording movies, you cannot switch the slot currently being used.
- When the remaining recording time of the memory card being used is less than 1 minute and the other slot has recordable memory card inserted, [ $\overline{\text{A}} \rightarrow \overline{\text{B}}$ ] or [ $\overline{\text{B}} \rightarrow \overline{\text{A}}$ ] appears on the camcorder screen. The indicator turns off when the memory card is switched.
- If you start recording on a memory card with the remaining recording time of less than 1 minute, the camcorder may not be able to relay-record. To relay-record without fail, make sure that the memory card has more than 1 minute when you start recording.
- Seamless playback of relay-recorded movies with this camcorder is not possible.
- You can re-combine relay-recorded movies using the application software "Content Browser".

## To record movies using both the memory card A and B (Simultaneous recording)

You can record movies on both of these recording media simultaneously.

Press MENU → select  $\left[ \begin{smallmatrix} \text{REC} \\ \text{OUT SET} \end{smallmatrix} \right]$  → [REC SET] → [SIMUL/RELAY REC] → [SIMULTANEOUS REC] with the  $\blacktriangle/\blacktriangledown/\blacktriangleleft/\blacktriangleright$ /EXEC button.

### Changing the setting of the START/STOP button and handle record button

When using SIMULTANEOUS REC, you can start and stop recording on different memory cards by using the START/STOP button and the handle record button. In the default setting, movies are recorded on both the memory card A and B at the same time when either record button is pressed.

- REC BUTTON:  $\overline{\text{A}}$   $\overline{\text{B}}$
- HANDLE REC BUTTON:  $\overline{\text{A}}$   $\overline{\text{B}}$

#### To change the setting

Press MENU → select  $\rightleftarrows$  (REC/OUT SET) → [REC SET] → [REC BUTTON SET] with the  $\blacktriangle/\blacktriangledown/\blacktriangleleft/\blacktriangleright$ /EXEC button.

[REC BUTTON:] setting	Button and recording media
REC BUTTON: $\overline{\text{A}}$ $\overline{\text{B}}$ HANDLE REC BUTTON: $\overline{\text{A}}$ $\overline{\text{B}}$	Recording on both the memory card A and the memory card B starts and stops at the same time when either record button is pressed.
REC BUTTON: $\overline{\text{A}}$ HANDLE REC BUTTON: $\overline{\text{B}}$	Recording on the memory card A starts and stops when the START/STOP button is pressed, and on the memory card B when the handle record button is pressed.
REC BUTTON: $\overline{\text{B}}$ HANDLE REC BUTTON: $\overline{\text{A}}$	Recording on the memory card B starts and stops when the START/STOP button is pressed, and on the memory card A when the handle record button is pressed.

## Adjusting the zoom

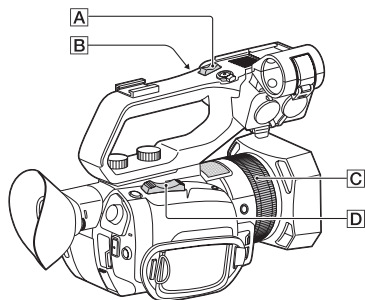

### Adjusting the zoom with the power zoom lever

Press the zoom lever **D** slightly to zoom slowly, and press it further to zoom more quickly.

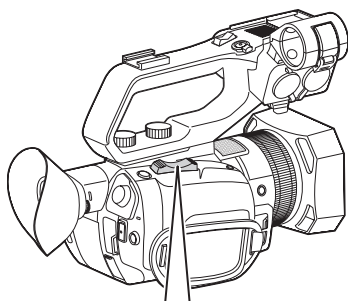

**Wide view:**  
(Wide angle)



**Close view:**  
(Telephoto)

### ⚡ Tips

- When focusing, the minimum distance required between the camcorder and the subject is about 1 cm (about 13/32 in.) for wide angle and about 1 meter (about 39 3/8 in.) for telephoto.
- The focus may not be adjusted at certain zoom positions if the subject is within 1 meter (about 39 3/8 in.) from your camcorder.
- Be sure to keep your finger on the power zoom lever **D**. If you move your finger off the power zoom lever **D**, the operation sound of the power zoom lever **D** may also be recorded.
- You can increase the zoom speed of the power zoom lever **D** or the handle zoom **A** ([SPEED ZOOM], p. 87).

### Adjusting the zoom with the handle zoom

- ① Set the handle zoom switch **B** to VAR or FIX.

### ⚡ Tips

- When you set the handle zoom switch **B** to VAR, you can zoom in or out at variable speed.
- When you set the handle zoom switch **B** to FIX, you can zoom in or out at fixed speed set in [HANDLE ZOOM] (p. 87).

- ② Press the handle zoom lever **A** to zoom in or out.

### ⚡ Notes

- You cannot use the handle zoom lever **A** when the handle zoom switch **B** is set to OFF.
- You cannot change the zoom speed of the power zoom lever **D** with the handle zoom switch **B**.

### Adjusting the zoom with the manual lens ring

If you toggle the ZOOM/FOCUS switch to ZOOM, you can zoom at the desired speed by turning the manual lens ring **C**. Fine adjustment is also possible.

### ⚡ Notes

- Turn the manual lens ring **C** at a moderate speed. If you turn it too fast, the zoom speed may lag behind the manual lens ring rotation speed, or the operation sound of the zoom may also be recorded.

# Adjusting the focus

You can adjust the focus manually for different recording conditions.

Use this function in the following cases.

- To record a subject behind a window covered with raindrops.
- To record horizontal stripes.
- To record a subject with little contrast between the subject and its background.
- When you want to focus on a subject in the background.

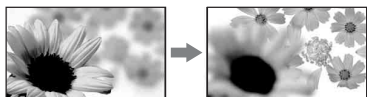

- To record a stationary subject using a tripod.

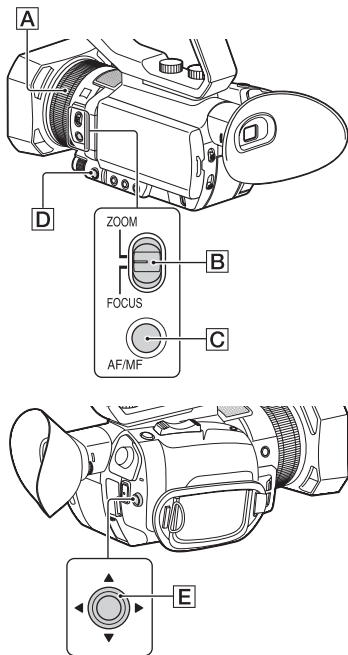

- 
- 1** During recording or standby, press the AF/MF button **C** to set the focus to manual.

appears.

- 
- 2** Move the ZOOM/FOCUS **B** switch, and turn the manual lens ring **A**.

- FOCUS: You can manually adjust the focus by turning the manual lens ring.
- ZOOM: You can manually adjust the zoom by turning the manual lens ring. changes to when the focus cannot be adjusted any farther. changes to when the focus cannot be adjusted any closer.

---

## To restore automatic adjustment

Press the AF/MF button **C** to set the focus to automatic.

disappears and the automatic focus adjustment is restored.

### Tips

- The focal length information (the distance at which the subject is in focus; for when it is dark and hard to adjust the focus) appears for about 3 seconds in the following cases.
  - When you press the AF/MF button to set the focus to manual and appears on the LCD screen.
  - When you rotate the manual lens ring **A** while is displayed on the LCD screen.
- You can switch the focal length information between meters and feet ([FOCUS DISPLAY], p. 96).

## Using the Focus magnifier

The selected area on the LCD screen is magnified and displayed. It is easier to confirm the focus setting during manual focusing.

[FOCUS MAGNIFIER] is assigned to the ASSIGN4 button (p. 64).

### Press ASSIGN4 button

The center of the screen is magnified. The setting changes with each press of the button.

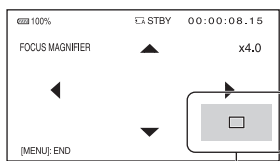

Enlarged display position

You can adjust the enlarged display position with the  $\blacktriangle/\blacktriangledown/\blacktriangleleft/\blacktriangleright$  button on the camcorder. Press the EXEC button to set the enlarged display position back to the center.

### Notes

- Even though the image appears expanded on the LCD screen, the recorded image is not expanded.

### Tips

- You can change the magnification ratio with [FOCUS MAG RATIO] (p. 95).

## Focusing by touching the LCD screen (Spot focus)

You can focus on the point where you touch on the LCD screen.

**1** Press the MENU button  $\square$ .

**2** Select  $\blacktriangleright$  (CAMERA SET)  $\rightarrow$  [SPOT FOCUS] with the  $\blacktriangle/\blacktriangledown/\blacktriangleleft/\blacktriangleright$  EXEC button  $\square$ .

**3** Touch the point to be focused on the LCD screen.

### Notes

- [SPOT FOCUS] is available only with manual focus.

### Tips

- You can assign this function to an ASSIGN button (p. 64).



### To cancel the spot focus

Press the MENU button  $\square$ .

## Focusing on a detected face (Face detection)

The camcorder detects the face and focuses on it (The default setting is [OFF]). [FACE DETECTION] is available only with automatic focus.

**1** Press the MENU button  $\square$ .

- 
- 2** Select  (CAMERA SET) → [FACE DETECTION] → [ON] or [OFF] with the ▲/▼/◀/▶/EXEC button .

When the faces are detected, frames appear on the LCD screen.

- 
- 3** Press the ▲/▼/◀/▶/EXEC button , move the selection cursor (orange colored frame) to select the priority face, then press the button again.

Selection cursor  
(orange colored frame)



Priority face frame  
(double frame)

The frame on the priority face changes to a double frame.

---

### To cancel the priority face

Move the selection cursor (orange colored frame) onto the frame (double frame) on the priority face, using the ▲/▼/◀/▶/EXEC button , then press the dial.

### 🔊 Notes

- Faces may not be detected depending on the recording environment, the condition of the subject or the settings.
- You may not be able to get the proper effect in some recording environments. If this happens, set [FACE DETECTION] to [OFF].
- The face detection function is disabled when using digital zoom or NIGHTSHOT.

### 💡 Tips

- You can assign this function to an ASSIGN button (p. 64).
- To make it easy to detect faces, record under the following conditions:
  - Record in a moderately bright place
  - Do not obscure the face with a hat, mask, sunglasses, etc.
  - Face the front of the camera



# Changing the recording setting

## Selecting the file format and recording format

You can select the file format in [FILE FORMAT] and the recording format (bit-rate, image size, frame rate, and scanning system) in [REC FORMAT].

You can select either XAVC HD or AVCHD for the file format on the camcorder. Select the desired file format that best suits the shooting situation and playback equipment.

**1** Press the MENU button.

**2** Press the ▲/▼/◀/▶/EXEC button to select ⇄ (REC/OUT SET) → [REC SET] → [FILE FORMAT] → the desired format.

**3** Select ⇄ (REC/OUT SET) → [REC SET] → [REC FORMAT] → a desired format with the ▲/▼/◀/▶/EXEC button.

## Setting value

For XAVC HD

60i	50i
1080/60p 50Mbps	1080/50p 50Mbps
1080/60p 35Mbps	1080/50p 35Mbps
1080/60i 50Mbps	1080/50i 50Mbps
1080/60i 35Mbps	1080/50i 35Mbps
1080/60i 25Mbps	1080/50i 25Mbps
1080/30p 50Mbps	1080/25p 50Mbps
1080/30p 35Mbps	1080/25p 35Mbps
1080/24p 50Mbps	-
1080/24p 35Mbps	-

60i	50i
720/60p 50Mbps	720/50p 50Mbps

For AVCHD

60i	50i
1080/60p PS	1080/50p PS
1080/60i FX	1080/50i FX
1080/60i FH	1080/50i FH
1080/30p FX	1080/25p FX
1080/30p FH	1080/25p FH
1080/24p FX	-
1080/24p FH	-
720/60p FX	720/50p FX
720/60p FH	720/50p FH
720/60p HQ	720/50p HQ

## Setting values

- Bit-rate  
PS: max. 28 Mbps  
FX: max. 24 Mbps  
FH: approx. 17 Mbps (average)  
HQ: approx. 9 Mbps (average)
- Image size  
1080: 1,920×1,080  
720: 1,280×720
- Frame rate  
Either 60, 50, 30, 25, or 24
- Scanning system  
i: interlace  
p: progressive

If you select [1080/60i FX] (when [60i] is selected) or [1080/50i FX] (when [50i] is selected), for example, movies are recorded with following format.

- 1080: Effective scanning lines
- 60, 50: Frame rate
- i: Scanning system
- FX: Recording mode

## Changing the recording setting (Continued)

### Frame rate when [60i] is selected

The frame rate displayed on the LCD screen differs from the actual frame rate.

Frame rate on the LCD screen	Actual frame rate
24	23.98
30	29.97
60	59.94

#### Tips

- When recording in DV, the recording format is fixed to 480/60i HQ (576/50i HQ).

### Setting the DV MODE (DV mode)

You can record/play back in DV mode of standard image quality

#### 1 Press the MENU button.

#### 2 Select (REC/OUT SET) → [REC SET] → [DV MODE] → [YES] with the /EXEC button.

The camcorder restarts in DV mode.



### Functions not available in DV mode

- Slow & Quick Motion recording
- Viewing still images
- Protecting recorded movies and still images (Protect)
  - [PROTECT] is not displayed on the [EDIT] menu.
- Dividing a movie
  - [DIVIDE] is not displayed on the [EDIT] menu.

#### Notes

- When DV mode is selected, the audio format is fixed to LPCM.



### The following items are available only when DV mode is selected:

-  (REC/OUT SET)
  -  WIDE REC
  - CANCEL DV MODE

#### Notes

- When you switch from DV mode to another, settings made in DV mode are initialized. If a movie file exceeds 2 GB during recording, the camcorder divides the recording into separate files by creating a new file(s) automatically. However, the divided files are displayed as a single movie on the screen of the camcorder.

### Canceling the DV MODE

- ① Press the MENU button.
- ② Select  (REC/OUT SET) → [REC SET] → [CANCEL DV MODE] → [YES] with the /EXEC button.

When DV mode is canceled, the following settings return to the default.

- S&Q MOTION
- REC SET
- AVCHD AUDIO FORMAT

# Adjusting the brightness

You can adjust the image brightness by adjusting the iris, gain or shutter speed, or by adjusting the light volume with the ND filter **E**.

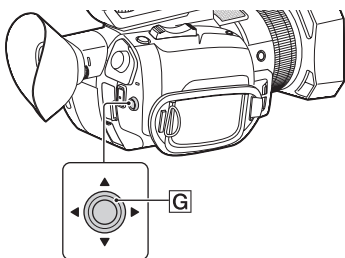
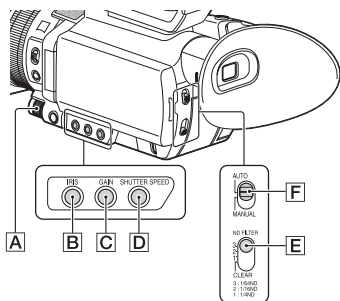

## Notes

- When you set the AUTO/MANUAL switch **F** to AUTO, iris, gain, shutter speed and white balance are adjusted automatically. You cannot adjust any of them manually.

## Adjusting the iris

This is handy for making the background blurred or sharp.

- 1 Set the AUTO/MANUAL switch **F** to MANUAL.

- 2 Press the IRIS button **B**.

The **A** or **E** next to the iris value disappears, and the iris value is highlighted.

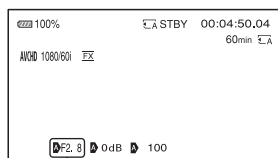

Iris value

- 3 Turn the MANUAL dial **A** to adjust the value.

The volume of the light increases the more that you open the aperture (decreasing F value). The volume of the light decreases the more that you close the aperture (increasing F value).

## To temporarily adjust the iris automatically

1. Hold the ASSIGN5/IRIS PUSH AUTO button down.

The iris is adjusted automatically for as long as you hold the button down.

## To adjust the iris automatically

Press the IRIS button **B** while the iris value is highlighted.

The iris value disappears or **A** appears next to the iris value. When AE is fixed, **E** appears next to the iris value.

## Adjusting the brightness (Continued)

### Adjusting the gain

You can use this if you do not want to increase the value by AGC (automatic gain control).

**1** Set the **AUTO/MANUAL** switch **[F]** to **MANUAL**.

**2** Press the **GAIN** button **[C]**.

The **[A]** or **[B]** next to the gain value disappears, and the gain value is highlighted.



Gain value

**3** Turn the **MANUAL** dial **[A]** to adjust the value.

### To adjust the gain automatically

Press the **GAIN** button **[C]** while the gain value is highlighted.

The gain value disappears, or **[A]** appears next to the gain value. When **AE** is fixed, **[B]** appears next to the gain value.

### Adjusting the shutter speed

You can adjust and fix the shutter speed manually. You can make a moving subject look still or emphasize the movement of a subject by adjusting the shutter speed.

**1** Set the **AUTO/MANUAL** switch **[F]** to **MANUAL**.

**2** Press the **SHUTTER SPEED** button **[D]**.

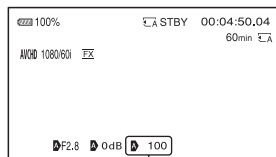

Shutter speed value

The **[A]** or **[B]** next to the shutter speed value disappears, and the shutter speed value is highlighted.

**3** Turn the **MANUAL** dial **[A]** to adjust the value.

When **[60i]** is selected: You can select from 1/8 to 1/10000 (1/6 - 1/10000 when shooting with 24p)  
When **[50i]** is selected: You can select from 1/6 to 1/10000

The denominator of the set shutter speed appears on the LCD screen. For example, **[100]** appears on the LCD screen when you set the shutter speed to 1/100 second. The larger the value on the LCD screen is, the faster the shutter speed is.

## 💡 Tips

- It is difficult to focus automatically at a lower shutter speed. Manual focusing with your camcorder attached to a tripod is recommended.
- When recording under fluorescent lamps, sodium lamps, or mercury lamps, the picture may flicker or change colors, or may have horizontal bands of noise. You may be able to improve the situation by adjusting the shutter speed to 1/50 if the power frequency of your area is 50 Hz, or 1/60 in a 60 Hz area.
- You can switch the shutter speed display between seconds and degrees ([SHUTTER DISPLAY], p. 96).

## To adjust the shutter speed automatically

Press the SHUTTER SPEED button **[D]** while the shutter speed value is highlighted. The shutter speed value disappears, or **[A]** appears next to the shutter speed value. When AE is fixed, **[E]** appears next to the shutter speed value.

## Adjusting the exposure

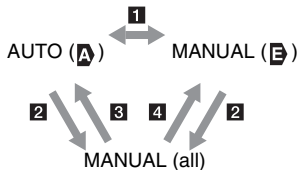

- 1** When you set AUTO/MANUAL switch in [SPOT METER] or [SPOT METER/ FOCUS]
- 2** When all of iris, gain and shutter speed are set manually.
- 3** When the last setting of the exposure is set to AUTO, and any item in **2** is set to AUTO.
- 4** When the last setting of the exposure is set to MANUAL, and any item in **2** is set to AUTO.

## 🔊 Notes

- When you set AUTO/MANUAL switch to AUTO, or press [EXEC] on the [SPOT METER] or [SPOT METER/FOCUS] screen, the exposure is returned to AUTO.

## Adjusting the volume of light (ND filter)

You can record the subject clearly by using the ND filter **[E]** when the recording environment is too bright. The ND filters 1, 2 and 3 reduce the volume of light to about 1/4, 1/16 and 1/64, respectively.

If **ND1** flashes during the iris automatic adjustment, set the ND filter to 1. If **ND2** flashes during the iris automatic adjustment, set the ND filter to 2. If **ND3** flashes during the iris automatic adjustment, set the ND filter to 3. The ND filter indicator will stop flashing and remain on the screen. If **NDOFF** flashes, set the ND filter **[E]** to OFF. The ND filter icon will disappear from the screen.

## 🔊 Notes

- If you change the ND filter **[E]** during recording, the movie and sound may be distorted.
- When adjusting the iris manually, the ND filter icon does not flash even if the light volume should be adjusted with the ND filter.
- If the camcorder cannot detect the ND filter position (OFF/1/2/3), **ND** flashes on the screen. Make sure that the ND filter is set correctly.

## 💡 Tips

- While recording a bright subject, diffraction may occur if you close the aperture further down, resulting in a fuzzy focus (this is a common phenomenon with video cameras). The ND filter **[E]** suppresses this phenomenon and gives better recording results.

# Adjusting the color tone

## Adjusting the white balance

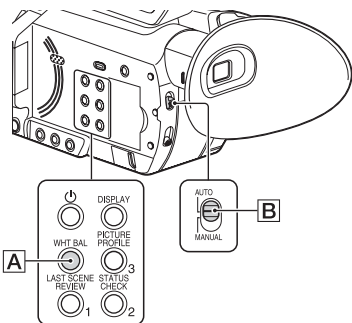

You can adjust and fix the white balance according to the lighting conditions of recording environment.

You can store white balance values in memory A (📷A) and memory B (📷B), respectively. Unless a white balance is readjusted, values will remain even after the power has been turned off.

When you select PRESET, [OUTDOOR], [INDOOR] or [MANU WB TEMP] is selected, according to which one you previously set with [WB PRESET] in the 📷 (CAMERA SET) menu.

### 💡 Tips

- You can assign [WB PRESET] to an ASSIGN button (p. 64).

**1** Set the **AUTO/MANUAL** switch **[B]** to **MANUAL**.

**2** Press the **WHT BAL** button **[A]**.

The white balance value is highlighted.

**3** Turn the **MANUAL** dial to select **PRESET, A, or B**.

### ■ Setting the A/B value

Select A or B for recording with the white balance setting stored in memory A or B.

See page 43 on how to store the adjusted value.

### ■ To use the PRESET value of white balance

Select 📷 (CAMERA SET) → [WB PRESET] → a desired setting.

Setting value	Example of recording conditions
☀️ (outdoor) ([OUTDOOR])	<ul style="list-style-type: none"><li>• When recording a night scene, neon lighting, fireworks, etc.</li><li>• When recording a sunrise, sunset, etc.</li><li>• Under daylight fluorescent lamp</li></ul>
💡 (indoor) ([INDOOR])	<ul style="list-style-type: none"><li>• Where lighting conditions change, such as at a party place, etc.</li><li>• Under video light, such as in a studio, etc.</li><li>• Under a sodium or mercury lamp</li></ul>
Color temperature setting ([MANU WB TEMP])	<ul style="list-style-type: none"><li>• You can set a desired color temperature between 2300K and 15000K with 📷 (CAMERA SET) → [WB TEMP SET]. (The default setting is 6500K.)</li></ul>

## To save the adjusted white balance value in memory A or B

- 1 Set the AUTO/MANUAL switch **[D]** to MANUAL.
- 2 Press the WHT BAL button to highlight the white balance value.
- 3 Turn the MANUAL dial to select A( A) or B( B).
- 4 Press the MENU button.
- 5 Press the ////EXEC buttons to select (CAMERA SET) → [WB SET].
- 6 Frame a white object such as a piece of paper that fills the screen under the same lighting conditions as your subject.
- 7 Press the EXEC button.  
The adjusted value is stored in A or B. The stored color temperature appears for about 3 seconds.

### Tips

- If [WB SET] is assigned to an ASSIGN button, the adjusted value is stored by pressing the ASSIGN button when the shooting screen is displayed, instead of performing step ⑦.

### Notes

- When a white balance adjustment value has not been obtained successfully, A or B turns to slow flashing. Adjust the subject appropriately and set the shutter speed to auto or around 1/60 (when [60i] is selected)/1/50 (when [50i] is selected), then try adjusting the white balance again.

## To adjust the white balance automatically

Press the WHT BAL button **[A]**.

### Notes

- When you set the AUTO/MANUAL switch **[B]** to AUTO, iris, gain, shutter speed and white balance are adjusted automatically. You cannot adjust manually.

## Audio setup

The jacks, switches and dials shown below allow you to set the sound that is recorded. See page 5 for details on attaching the microphone.

### Recording sound from the internal microphone

You can record sound in stereo using the camcorder's internal microphone.

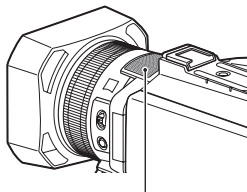

Internal microphone

Select [INT MIC] in the [MIC SELECT] menu.

### Tips

- To reduce wind noise, set [INT MIC WIND] to [ON].

### Recording sound from an external audio device

When using a microphone with XLR-type connector (sold separately) or external audio device (such as a mixer), configure the settings as described below.

## Audio setup (Continued)

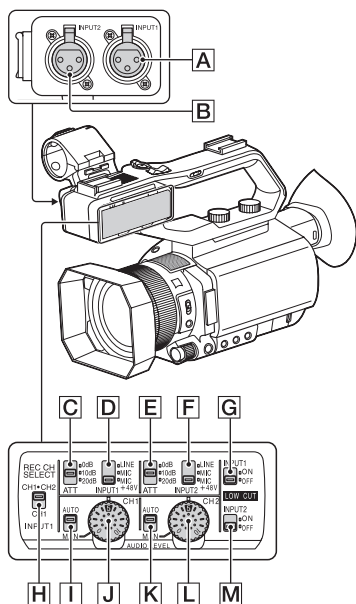

### External audio input jacks

- A**: INPUT1 jack
- B**: INPUT2 jack

### Audio source switches

- D**: INPUT1 (LINE/MIC/MIC+48V) switch
- F**: INPUT2 (LINE/MIC/MIC+48V) switch

### Audio source level controls

- C**: ATT (INPUT1) switch
- E**: ATT (INPUT2) switch

### Recording channel switch

- H**: REC CH SELECT (INPUT1) switch

### Audio level controls

- I**: AUTO/MAN (CH1) switch
- J**: AUDIO LEVEL (CH1) dial
- K**: AUTO/MAN (CH2) switch
- L**: AUDIO LEVEL (CH2) dial

### Wind noise switches

- G**: LOW CUT (INPUT1) switch
- M**: LOW CUT (INPUT2) switch

## 1 Select the audio input source.

Set the INPUT1/INPUT2 (LINE/MIC/MIC+48V) switch (**D** or **F**) based on the device connected to INPUT1 jack **A**/INPUT2 jack **B**.

Connected device	Switch position
External audio device (such as mixer)	LINE
Dynamic microphone or microphone with built-in battery	MIC
+48V powered (phantom powered) microphone	MIC+48V

### ⚠ Notes

- If the switch is set to MIC+48V and you connect a device that is not compatible with +48V power, it may damage the connected device. Check the switch before connecting the device.
- To prevent unwanted noise when no audio device is connected to the INPUT1 or INPUT2 jack, set the INPUT1/INPUT2 (LINE/MIC/MIC+48V) switch (**D** or **F**) to LINE.



## 2 Set the microphone input level.

When the INPUT1/INPUT2 (LINE/MIC/MIC+48V) switch (**[D]** or **[F]**) is set to MIC or MIC+48V, the input level can be set using the ATT (INPUT1/INPUT2) switch (**[C]** or **[E]**). Adjust the setting based on the sensitivity of the microphone.

ATT 0dB: -60dBu

ATT 10dB: -50dBu



ATT 20dB: -40dBu

### Notes

- The input level is fixed to +4dBu when the INPUT1/INPUT2 (LINE/MIC/MIC+48V) switch (**[D]** or **[F]**) is set to LINE. The input level does not change, even if you change the ATT switch setting.

## 3 Select the channel to record.

With the REC CH SELECT (INPUT 1) switch (**[H]**), select the channel to record.

REC CH SELECT (INPUT1) switch setting	Sound recorded to CH1 and CH2
CH1-CH2	INPUT1  CH1 CH2
CH1	INPUT1  CH1 INPUT2  CH2

### Tips

- When using a stereo microphone with two XLR (3-pin) plugs, connect the INPUT1 jack (**[A]**) to the left channel, connect the INPUT2 jack (**[B]**) to the right channel, and set the REC CH SELECT (INPUT1) switch (**[H]**) to CH1.

## Recording sound from a Multi Interface Shoe compatible microphone (sold separately)

You can record sound in stereo using a Multi Interface Shoe compatible microphone.

- 1 Connect the Multi Interface Shoe compatible microphone (sold separately) to the Multi Interface Shoe.

- 2 Select **[MI SHOE MIC]** in the **[MIC SELECT]** menu.

## Recording sound from an external microphone (sold separately)

You can record sound in stereo using an external microphone (sold separately).

- 1 Connect the external microphone (sold separately) to the MIC jack (**PLUG IN POWER**).

- 2 Select **[STEREO MINI MIC]** in the **[MIC SELECT]** menu.

## Audio setup (Continued)

### Adjusting the audio level from the INPUT1 and INPUT2 jacks

You can adjust the audio level for the sound that is input from the INPUT1 and INPUT2 jacks.

---

**1** Set the **AUTO/MAN** switch to **MAN** for the channel that you want to adjust (**CH1** or **CH2**).

---

**2** Turn the **AUDIO LEVEL** dial to adjust the audio level.

Use headphones or an audio level meter to check that the audio level is appropriate.

#### To restore automatic adjustment

- Set the **AUTO/MAN** switch to **AUTO** to restore automatic adjustment for sound that is input from the **INPUT1** and **INPUT2** jacks.

### Adjusting the audio level from the internal microphone or an external microphone (PLUG IN POWER)

You can adjust the audio level for the sound that is input from the internal microphone or an external microphone (**PLUG IN POWER**).

---

**1** Select **[MANUAL]** in the **[REC LEVEL MODE]** menu in **[AUDIO REC LEVEL]**.

---

**2** During recording or standby, adjust the microphone volume in the **[MANUAL REC LEVEL]** menu in **[AUDIO REC LEVEL]**.

This enables you to apply the same audio level setting to the **CH1/CH2** channels.

#### To restore automatic adjustment

- Select **[NORMAL]** or **[HIGH]** in the **[REC LEVEL MODE]** menu in **[AUDIO REC LEVEL]**.

# Useful functions

## Selecting the suitable setting automatically for the recording situation (AUTO MODE setting)

You can make optimal recordings in various situations.

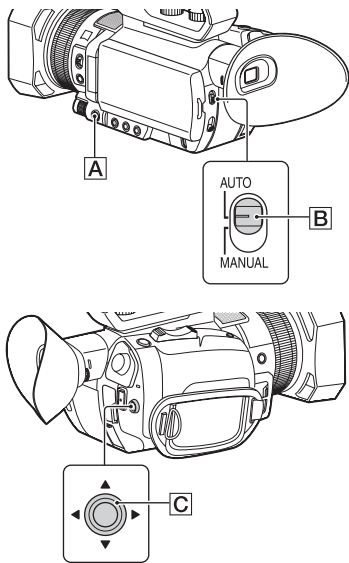

**1** Set the **AUTO/MANUAL** switch **[B]** to **AUTO**.

**2** Press the **MENU** button **[A]**.

**3** Select **[CAMERA SET]** → **[AUTO MODE SET]** with the **▲/▼/◀/▶/EXEC** button **[C]**.

**4** Press the **▲/▼/◀/▶/EXEC** button **[C]**, select **[AUTO]**, **[INTELLIGENT AUTO]**, or **[SCENE SELECTION]**, and press the button again.

### Notes

- When you select **[INTELLIGENT AUTO]**, **[STEADY SHOT]** is set to **[ACTIVE]**, and the angle of view shifts 1.08 times toward the telephoto side.

### Scenes detected by INTELLIGENT AUTO

Face detection: 👤 (Portrait), 👶 (Baby)

Scene detection: 🌃 (Backlight),

🏞️ (Landscape), 🌙 (Night Scene),

🔦 (Spotlight), 📷 (Low Brightness),

🌸 (Macro)

Camera-shake detection: 🚶 (Walk),





📵 (Tripod)

### To use [SCENE SELECTION]

- Press the **MENU** button, press the **▲/▼/◀/▶/EXEC** button and select **[CAMERASET]** → **[SCENE SELECTION SET]**, then press the button again.
- Press the **▲/▼/◀/▶/EXEC** button, select the desired setting, then press the button again.

Setting	Recording conditions
🌙 Night Scene* ([NIGHT SCENE])	Shoots a night view with a proper exposure, using a tripod (sold separately).
🌅 Sunrise & Sunset* ([SUNRISE & SUNSET])	Shoots the scenes under the glow of sunset/sunrise vividly.

## Useful functions (Continued)

Setting	Recording conditions
 Fireworks* ([FIREWORKS])	Shoots fireworks with optimal exposure.
 Landscape* ([LANDSCAPE])	Shoots distant subjects clearly. This setting also prevents your camcorder from focusing on any glass or mesh in windows between the camcorder and the subject.
 Portrait ([PORTRAIT])	Brings out the subject, such as people or flowers, while creating a soft background.
 Spotlight ([SPOTLIGHT])	Prevents people's faces from appearing excessively white when subjects are lit by strong light.
 Beach ([BEACH])	Takes the vivid blue of the ocean or a lake.

\* Focuses on only distant subjects.

## Shooting in dark conditions (NIGHTSHOT)

You can shoot scenes under very dark conditions.

### 1 Assign [NIGHTSHOT] to an ASSIGN button. (p. 64)

### 2 Press the ASSIGN button.

-  is displayed.
- To cancel, press the ASSIGN button again.

## Notes

- NIGHTSHOT can only be used when the AUTO/MANUAL switch is set to AUTO.
- NIGHTSHOT uses infrared light. Make sure that your finger does not cover the infrared light emitter when shooting.
- Remove the lens hood.
- Do not use NIGHTSHOT in bright conditions. Doing so may damage the camcorder.

## What you can do with the Wi-Fi function of the camcorder

The Wi-Fi function of the camcorder enables you to operate the camcorder remotely by a smartphone.

### Using a smartphone as a remote controller (One-touch remote (NFC))

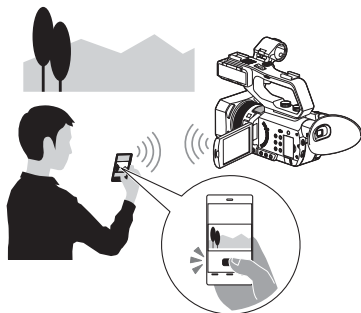

### Required equipment/environment

Smartphone or tablet computer

## Downloading "Content Browser Mobile"

To use a smartphone as a remote control for the camcorder, you need to install the dedicated application "Content Browser Mobile" on your smartphone. If "Content Browser Mobile" is already installed on your smartphone, update it to the latest version as necessary.

## Android OS

Search for “Content Browser Mobile” in Google Play, then install it.



- You need Android 4.1 or later when you use the NFC One-touch.

## iOS

Search for “Content Browser Mobile” in the App Store, then install it.



- You need iOS 7.0 or later.
- You cannot use the NFC One-touch when you use iOS.

### Notes

- You need an NFC-compatible smartphone or tablet computer in order to use the NFC One-touch function of the camcorder.
- Proper operation of the Wi-Fi function detailed in this manual is not guaranteed for all smartphones or tablet computers.
- Operations and screen displays of the application may be subject to change without notice by future upgrades.

## Connecting the camcorder to an Android smartphone equipped with the NFC function using One-touch

- 1** Select [Settings] on the smartphone, then select [More...] and place a checkmark next to [NFC].

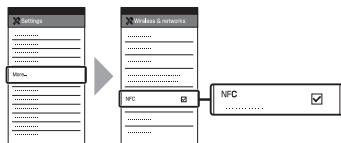

- 2** Set the camcorder to the shooting mode.

You can use the NFC function only when **N** (N-Mark) is displayed on the screen.

- 3** Touch the smartphone on the camcorder.

The smartphone connects to the camcorder, “Content Browser Mobile” is activated and [CTRL W/ SMARTPHONE] starts on the camcorder.

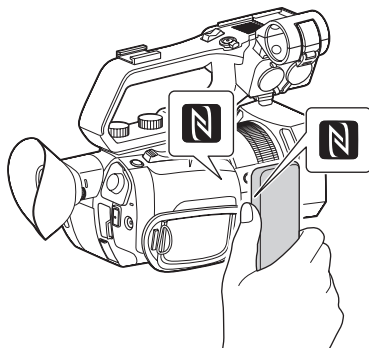

## Useful functions (Continued)

### 🔊 Notes

- Cancel the sleep mode and screen lock of the smartphone beforehand.
- Continue to touch (1 second-2 seconds) on the camcorder without moving, until “Content Browser Mobile” starts up.
- While [CTRL W/SMARTPHONE] is activated, only the START/STOP button and handle record button are available on the camcorder.
- The smartphone cannot be connected to the camcorder when [AIRPLANE MODE] is set to [ON]. Set [AIRPLANE MODE] to [OFF] (p. 99).

### Using a smartphone as a remote controller

You can control some of the camcorder's movie shooting functions remotely with a smartphone.

To start [CTRL W/SMARTPHONE] using the NFC function, see page 49.

#### 1 Press the MENU button.

#### 2 Select (NETWORK SET) → [CTRL W/SMARTPHONE] with the /EXEC button.

#### 3 Connect the smartphone to the camcorder, using the information that appears on the screen when the camcorder is ready to be connected.

The connection method will depend on the type of smartphone.

Android: See page 51.

iPhone/iPad: See page 52.

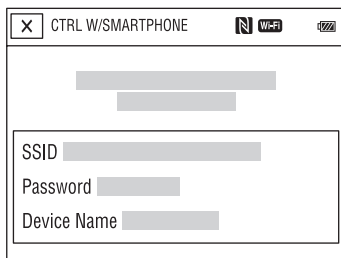

#### 4 Operate the camcorder by the smartphone.

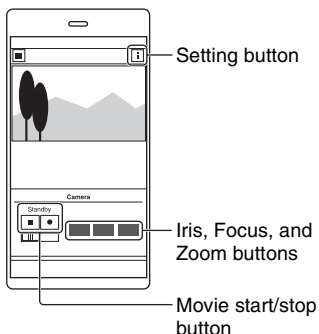

### 🔊 Notes

- Live view images may not be displayed smoothly, depending on the smartphone performance and/or transmission conditions.
- Movies cannot be recorded on a smartphone.

### 💡 Tips

- If you assign [SMARTPHONE CONNECT] to an ASSIGN button, you can start [CTRL W/SMARTPHONE] by pressing that ASSIGN button when the shooting screen is displayed (p. 64).
- To start [CTRL W/SMARTPHONE] in Slow & Quick Motion mode, perform one-touch connection with an NFC-compatible smartphone, or press the ASSIGN button to which [SMARTPHONE CONNECT] is assigned.

## Functions operable by [CTRL W/ SMARTPHONE]

- Recording start/stop
- Touch focus  
Available when using manual focus.
- Zoom
- Iris adjustment  
While the smartphone is connected to the camcorder, CLOSE cannot be selected.

### Notes

- You cannot perform other operations during touch focus.

## Connecting without using the NFC function (Android)

- 1 Select [Settings] on your smartphone, then select [Wi-Fi] and the SSID (displayed on the camcorder).

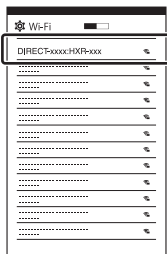

- 2 Input the password displayed on the camcorder (first time only).

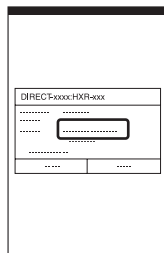

- 3 Confirm connection to the SSID displayed on the camcorder.

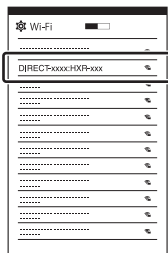

### Tips

- The next time that you want to connect to the camcorder, select the camcorder in the device list in the Connect menu, and select [Connect].

- Return to the Home screen, then start “Content Browser Mobile.”

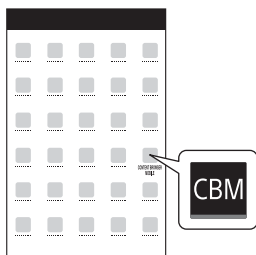

- Input the password displayed on the camcorder (first time only).

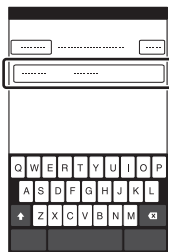

For details on how to operate “Content Browser Mobile” after it starts, refer to the Help section in “Content Browser Mobile”.

### Connecting without using the NFC function (iPhone/iPad)

- Select [Settings] on the iPhone or iPad, then select [Wi-Fi] and the SSID (displayed on the camcorder).

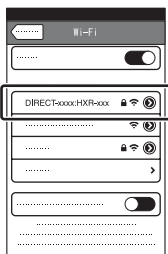

- Confirm connection to the SSID displayed on the camcorder.

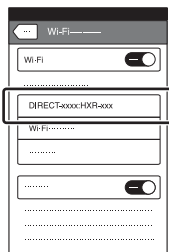

- Return to the Home screen, then start “Content Browser Mobile.”

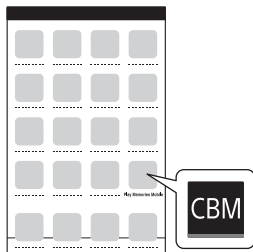



For details on how to operate “Content Browser Mobile” after it starts, refer to the Help section in “Content Browser Mobile”.

## Customizing the picture quality (Picture profile)

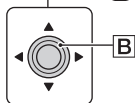
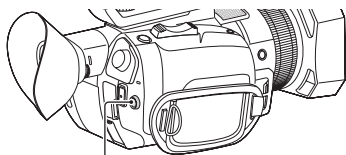
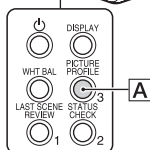
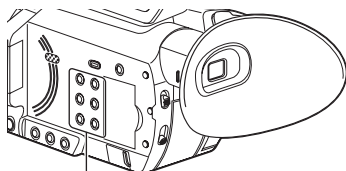

You can customize the picture quality by adjusting picture profile items such as [GAMMA] and [DETAIL].

You can make adjustments for the time of day, weather conditions, or just personal preference.

Connect your camcorder to a TV or monitor, and adjust the picture quality while observing the picture on the TV or monitor screen.

Picture quality settings for different recording conditions have been stored in [PP1] through [PP6] as default settings. [PICTURE PROFILE] is assigned to the ASSIGN3 button **A** (p. 64).

## Notes

- [PP4] is set for the picture profile by default.

Picture profile number	Example setting
PP1	Example settings of a color tone with [STANDARD] gamma
PP2	Example settings of a color tone with [STILL] gamma
PP3	Example settings of natural color tone with [ITU-709] gamma
PP4	Example settings of a color tone that is faithful to [ITU-709]
PP5	Example settings of pictures recorded on cinema color negative film
PP6	Example settings of pictures screened with cinema color print film

**1** Press the ASSIGN3 button **A** during standby.

**2** Press the  $\blacktriangle/\blacktriangledown/\blacktriangleleft/\blacktriangleright$ /EXEC button **B**, select the picture profile number, then press the button again.

You can record with the settings of the selected picture profile.

**3** Press the  $\blacktriangle/\blacktriangledown/\blacktriangleleft/\blacktriangleright$ /EXEC button **B**, select [OK], then press the button again.

## Useful functions (Continued)

### To cancel the picture profile recording

Select [OFF] in step 2 with the ▲/▼/◀/▶/EXEC button [B], then press the button.

### To change the picture profile

You can change the settings stored in [PP1] through [PP6].

- ① Press the ASSIGN3 button [A].
- ② Press the ▲/▼/◀/▶/EXEC button [B], select the picture profile number that you want to change, then press the button again.
- ③ Press the ▲/▼/◀/▶/EXEC button [B], select [SETTING], then press the button again.
- ④ Press the ▲/▼/◀/▶/EXEC button [B], select the item that you want to adjust, then press the button again.
- ⑤ Press the ▲/▼/◀/▶/EXEC button [B], adjust the picture quality, then press the button again.
- ⑥ Repeat steps ④ and ⑤ to adjust other items.
- ⑦ Press the ▲/▼/◀/▶/EXEC button [B], select ↵ [RETURN], then press the button again.
- ⑧ Turn the ▲/▼/◀/▶/EXEC button [B] to select [OK], then press the button again. The picture profile indicator is displayed.

## BLACK LEVEL

To set the black level.

Item	Description and settings
	Sets the black level. -15 to +15

## GAMMA

To select a gamma curve.

Item	Description and settings
[STANDARD]	Standard gamma curve
[STILL]	Gamma curve to create the tone of a still image.
[CINEMATONE1]	Gamma curve 1 for producing tone of film camera images
[CINEMATONE2]	Gamma curve 2 for producing tone of film camera images
[ITU709]	Gamma curve that corresponds to ITU-709. Gain in low intensity area: 4.5

### 🔊 Notes

- There is no still image shooting mode on the camcorder.

## BLACK GAMMA

To correct gamma in low intensity area.

Item	Description and settings
[RANGE]	Selects a correcting range. HIGH / MIDDLE / LOW
[LEVEL]	Sets the correcting level. -7 (maximum black compression) to +7 (maximum black stretch)

## Useful functions (Continued)

### KNEE

To set knee point and slope for video signal compression to prevent over-exposure by limiting signals in high intensity areas of the subject to the dynamic range of your camcorder.

When selecting [STANDARD] or [STILL] in [GAMMA], [KNEE] is set to off if [MODE] is set to [AUTO]. To use functions in [KNEE], set [MODE] to [MANUAL].

Item	Description and settings
[MODE]	Selects a mode either automatic or manual. [AUTO] : Sets the knee point and slope automatically. [MANUAL] : Sets the knee point and slope manually.
[AUTO SET]	Sets the maximum point and sensitivity in the automatic mode. [MAX POINT] : Sets the maximum point. 90% to 100% [SENSITIVITY] : Sets the sensitivity. HIGH / MIDDLE / LOW
[MANUAL SET]	Sets the knee point and slope manually. [POINT] : Sets the knee point. 75% to 105% [SLOPE] : Sets the knee slope. -5 (gentle) to +5 (steep) [KNEE] is set to off when you set to +5.

### COLOR MODE

To set type and level of colors.

Item	Description and settings
[STANDARD]	Suitable colors when [GAMMA] is set to [STANDARD].
[STILL]	Suitable colors when [GAMMA] is set to [STILL].
[CINEMATONE1]	Film camera image-like colors good with [GAMMA] set to [CINEMATONE1].
[CINEMATONE2]	Film camera image-like colors good with [GAMMA] set to [CINEMATONE2].
[PRO]	Natural colors when [GAMMA] is set to [ITU-709].
[ITU709 MATRIX]	Colors that are faithful to the ITU-709 standard (when used with ITU-709 gamma).
[B/W]	Sets the saturation to 0 and records in black and white.

## SATURATION

To set the color level.

Item	Description and settings
	- 32 (light) to +32 (dark)

## COLOR PHASE

To set the color phase.

Item	Description and settings
	-7 (greenish) to +7 (reddish)

## COLOR DEPTH

To set the color depth for each color phase.

This function is more effective for chromatic colors and less effective for achromatic colors. The color looks deeper as you increase the setting value to more positive side, and lighter as you decrease the value to more negative side. This function is effective even if you set [COLOR LEVEL] to [-8] (black and white).

Item	Description and settings
[R]	-7 (light red) to +7 (deep red)
[G]	-7 (light green) to +7 (deep green)
[B]	-7 (light blue) to +7 (deep blue)
[C]	-7 (light cyan) to +7 (deep cyan)
[M]	-7 (light magenta) to +7 (deep magenta)
[Y]	-7 (light yellow) to +7 (deep yellow)

## COLOR CORRECTION

To set the color correction.

Item	Description and settings
TYPE	<p>Selects color correction type.</p> <p>[OFF] : Not correct colors.</p> <p>[COLOR REVISION]: Corrects colors stored in memory. Colors not stored in memory (displayed in black and white when [COLOR EXTRACT] is set) will not be corrected.</p> <p>[COLOR EXTRACT]: Displays areas in colors that are stored in the memory. The other areas are displayed in black and white. You can use this function to add effects on your movies or to confirm the colors to be stored in the memory.</p>
MEMORY SELECTION	<p>Selects a memory to be effective.</p> <p>[1] : Sets Memory 1 to be effective.</p> <p>[2] : Sets Memory 2 to be effective.</p> <p>[1&amp;2] : Sets both Memory 1 and 2 to be effective.</p>

## Useful functions (Continued)

Item	Description and settings
MEMORY1 COLOR	Sets colors stored in Memory 1. [PHASE] : Sets color phase. 0 (purple) → 8 (red) → 16 (yellow) → 24 (green) → 31 (blue) [PHASE RANGE]: Sets color phase range. 0 (no color selection), 1 (narrow: to select only a single color) to 31 (wide: to select multiple colors in similar color phase) [SATURATION] : Sets saturation. 0 (to select from light colors to dark colors) to 31(to select dark color) [ONE PUSH SET]: Automatically sets [PHASE] for a subject at the center of the marker. [SATURATION] is set to 0.
MEMORY1 REVISION	Corrects colors in Memory 1. [PHASE] : Corrects the phase of the color in Memory 1. -15 to +15 (0 for no correction.) [SATURATION]: Corrects the saturation of the color in Memory 1. -15 to +15 (0 for no correction.)
MEMORY2 COLOR	Sets colors stored in Memory 2. See [MEMORY1 COLOR] for description and settings.
MEMORY2 REVISION	Corrects colors in Memory 2. See [MEMORY1 REVISION] for description and settings.

### Tips

- Setting both memories to the same setting doubles the color correction effect.
- The settings of [COLOR CORRECTION] will be retained even if the power is turned off. However, if you want to correct colors that may change according to time of the day, weather, location, etc., it is recommended that you set [COLOR CORRECTION] again prior to recording.
- If you change the white balance value or the settings of [WB SHIFT], [SATURATION] or [COLOR PHASE] of the picture profile, the settings of [PHASE RANGE] and [PHASE] of the selected memory will change. When you change the white balance value or the settings of the above picture profile items after you have set [PHASE RANGE] and [PHASE], check the settings of [COLOR CORRECTION] prior to recording.
- During the automatic white balance adjustment, the white balance value automatically varies according to the lighting conditions of your recording environment. The manual white balance adjustment is recommended when you use [COLOR CORRECTION].

## WB SHIFT

To set items for the white balance shift.

Items you can adjust differ depending on the filter type.

Item	Description and settings
[FILTER TYPE]	Selects a color filter type for the white balance shift. [LB-CC] : Film type (color conversion and correction) [R-B] : Video type (correction of R and B levels)
[LB[COLOR TEMP]]	Sets a color temperature offset value. -9 (bluish) to +9 (reddish)

Item	Description and settings
[CC[MG/GR]]	Sets a color correct offset value. -9 (greenish) to +9 (magentish)
[R GAIN]	Sets an R level. -9 (low R level) to +9 (high R level)
[B GAIN]	Sets a B level. -9 (low B level) to +9 (high B level)

## DETAIL

To set items for the detail.

Item	Description and settings
[LEVEL]	Sets the detail level. -7 to +7
[MANUAL SET]	[ON/OFF] : Turns on and off the manual detail adjustment. Set to [ON] to enable the manual detail adjustment (automatic optimization will not be performed).
	[V/H BALANCE] : Sets the vertical (V) and horizontal (H) balance of DETAIL. -2 (off to the vertical (V) side) to +2 (off to the horizontal (H) side)
	[B/W BALANCE] : Selects the balance of the lower DETAIL (B) and the upper DETAIL (W). TYPE1 (off to the lower DETAIL (B) side) to TYPE5 (off to the upper DETAIL (W) side)
	[LIMIT] : Sets the limit level of DETAIL. 0 (Low limit level: likely to be limited) to 7 (High limit level: not likely to be limited)
	[CRISPENING] : Sets the crispening level. 0 (shallow crispening level) to 7 (deep crispening level)
	[HI-LIGHT DETAIL] : Sets the DETAIL level in the high intensity areas. 0 to 4

## COPY

To copy the settings of the picture profile to another picture profile number.

## RESET

To reset the picture profile to the default setting.

## Useful functions (Continued)

### To copy the picture profile setting to another picture profile number

See page 53 for the location of the buttons.

- ① Press the ASSIGN3 button **A**.
- ② Press the **▲/▼/◀/▶/EXEC** button **B**, select the picture profile number that you want to copy from, then press the button again.
- ③ Press the **▲/▼/◀/▶/EXEC** button **B**, then select [SETTING] → [COPY].
- ④ Press the **▲/▼/◀/▶/EXEC** button **B**, select the picture profile number that you want to copy to, then press the button again.
- ⑤ Press the **▲/▼/◀/▶/EXEC** button **B**, then select [YES] → [RETURN] → [OK].

### To reset the picture profile settings

You can reset the picture profile settings by each picture profile number. You cannot reset all picture profile settings at once. See page 53 for the location of the buttons.

- ① Press the ASSIGN3 button **A**.
- ② Press the **▲/▼/◀/▶/EXEC** button **B**, select the picture profile number that you want to reset, then press the button again.
- ③ Press the **▲/▼/◀/▶/EXEC** button **B**, then select [SETTING] → [RESET] → [YES] →  [RETURN] → [OK].

## Setting time data

The camcorder records movies accompanied by time data, such as time code and user bit.

### Presetting the time code

- ① Press the MENU button, press the **▲/▼/◀/▶/EXEC** button and select **00:00** (TC/UB SET) → [TC PRESET], then press the button again.

- ② Press the **▲/▼/◀/▶/EXEC** button, select [PRESET], then press the button again.
- ③ Press the **▲/▼/◀/▶/EXEC** button, select the first two digits, then press the button again.  
You can set the time code within the following range.  
When [60i] is selected:  
00:00:00:00 - 23:59:59:29
  - When setting 24p, you can set the last 2 time code digits of the frames in multiples of 4, between 0 and 23.When [50i] is selected:  
00:00:00:00 - 23:59:59:24
- ④ Set other digits by repeating step ③.
- ⑤ Press the **▲/▼/◀/▶/EXEC** button, select [OK], then press the button again.

### To reset the time code

You can reset the time code (00:00:00:00). Select [RESET] in step ② of “Presetting the time code.”

### To reset the time code using the Wireless Remote Commander

You can reset the time code (00:00:00:00) also by pressing the TC RESET button on the Wireless Remote Commander.

### Presetting the user bit

- ① Press the MENU button, press the **▲/▼/◀/▶/EXEC** button and select **00:00** (TC/UB SET) → [UB PRESET], then press the button again.
- ② Press the **▲/▼/◀/▶/EXEC** button, select [PRESET], then press the button again.
- ③ Press the **▲/▼/◀/▶/EXEC** button, select the first two digits, then press the button again.
- ④ Set other digits by repeating step ③.
- ⑤ Press the **▲/▼/◀/▶/EXEC** button, select [OK], then press the button again.



## To reset the user bit

You can reset the user bit (00 00 00 00). Select [RESET] in step ② of “Presetting the user bit.”

## Recording with the Slow & Quick Motion function

By recording with a frame rate that is different from the playback frame rate, you can record images to be played back as slow motion or quick motion images. The images recorded with the Slow & Quick Motion function will appear smoother than slow or fast-forward playback of images recorded at normal speed.

You can use Slow & Quick Motion function with XAVC HD and AVCHD.

## Playback speed

The playback speeds based on the recording format and frame rate setting are as follows.

### When [60i] is selected

FRAME RATE	REC FORMAT		
	1080/24p	1080/30p	1080/60p
60	40% slow	50% slow	100% (standard)
30	80% slow	100% (standard)	200% quick
15	160% quick	200% quick	400% quick
8	300% quick	375% quick	750% quick
4	600% quick	750% quick	1500% quick
2	1200% quick	1500% quick	3000% quick
1	2400% quick	3000% quick	6000% quick

### When [50i] is selected

FRAME RATE	REC FORMAT	
	1080/25p	1080/50p
50	50% slow	100% (standard)
25	100% (standard)	200% quick
12	208% quick	417% quick
6	417% quick	833% quick
3	833% quick	1667% quick
2	1250% quick	2500% quick
1	2500% quick	5000% quick

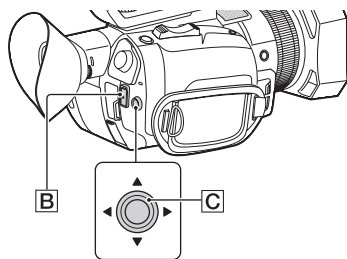
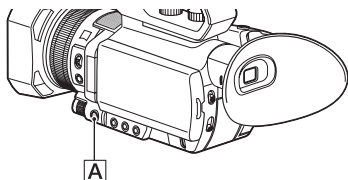

## Notes

- For details about the memory cards that can be used to record with Slow & Quick Motion, see page 27.
- When recording with the Quick Motion recording function, your camcorder may continue recording for some time (approximately 30 seconds at most) after you press the button to stop recording. Do not operate your camcorder while the [REC] indicator is flashing on the screen, and wait till it turns to [STBY].
- After you press the button to stop recording, your camcorder continues recording till it completes writing of the minimum unit of data (0.5 seconds of replay time).

## Useful functions (Continued)

### Preparation

You must set the recording format and frame rate.

- Press the MENU button **[A]**.
- Select  (CAMERA SET) → [S&Q MOTION] → [REC FORMAT] with the **▲/▼/◀/▶/EXEC** button **[C]**.
- Select a recording format.  
Setting values  
[XAVC HD]

60i	50i
1080/60p 50Mbps	1080/50p 50Mbps
1080/60p 35Mbps	1080/50p 35Mbps
1080/30p 50Mbps	1080/25p 50Mbps
1080/30p 35Mbps	1080/25p 35Mbps
1080/24p 50Mbps	-
1080/24p 35Mbps	-

[AVCHD]

60i	50i
1080/60p PS	1080/50p PS
1080/30p FX	1080/25p FX
1080/30p FH	1080/25p FH
1080/24p FX	-
1080/24p FH	-

- Select [FRAME RATE] with the **▲/▼/◀/▶/EXEC** button **[C]**, and set a desired frame rate.  
[XAVC HD]

60i	50i
60fps	50fps
30fps	25fps
15fps	12fps
8fps	6fps
4fps	3fps
2fps	2fps
1fps	1fps

[AVCHD]

60i	50i
60fps	50fps
30fps	25fps
15fps	12fps
8fps	6fps
4fps	3fps
2fps	2fps
1fps	1fps

- Select [**↵** RETURN].

### To record with the Slow & Quick Motion function

- Press the **▲/▼/◀/▶/EXEC** button to select  (CAMERA SET) → [S&Q MOTION] → [EXECUTE], or assign [S&Q MOTION] to an ASSIGN button and then press the ASSIGN button.
- Press the START/STOP button **[B]**.  
Recording starts.

### To stop Slow & Quick Motion recording

Press the START/STOP button **[B]** again.

## To change the frame rate setting

Hold the ASSIGN button down for about 1 second, then change the value with the ▲/▼/◀/▶/EXEC button [C].

Holding the ASSIGN button down again for about 1 second restores the previous setting.

## To cancel Slow & Quick Motion recording

Press the ASSIGN button or the MENU button [A] during standby.

### 💡 Notes

- When you are recording with a slow frame rate, the camcorder may continue recording for a few more seconds after you press the START/STOP button to stop recording.
- You cannot change the frame rate during Slow & Quick Motion recording. To change the frame rate, stop current Slow & Quick Motion recording.
- The time code is recorded in the [REC RUN] mode during Slow & Quick Motion recording (p. 98).
- Slow & Quick Motion mode is automatically canceled when the camcorder is turned off, but the frame rate setting is retained.
- You cannot record sound during Slow & Quick Motion recording.
- You cannot use the Slow & Quick Motion function for the simultaneous recording.
- You cannot use the Slow & Quick Motion function with DV.

## Reviewing the most recently recorded scene (Last Scene Review)

You can review the most recently recorded scene on the LCD screen.

[LAST SCENE REVIEW] is assigned to the ASSIGN1 button.

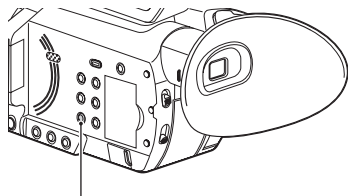

ASSIGN1 button

**Right after you stop recording, press the ASSIGN1 button.**

The camcorder plays from the top to the end of the most recently recorded scene, then returns to standby mode.

## To stop reviewing the last scene

Press the ASSIGN1 button during playback. The camcorder returns to standby mode.

### ⚙️ Notes

- If you edit the movie or remove the recording media after you stop recording, the Last Scene Review function may not work correctly.

# Assigning the functions to the ASSIGN buttons

Some functions can be assigned to the ASSIGN buttons for use. You can assign a single function to any one of the ASSIGN 1 to 6 buttons.

See “Menu items” (p. 83) on the function of each item.

## Default function of each ASSIGN button

- ASSIGN1: LAST SCENE REVIEW (p. 63)
- ASSIGN2: STATUS CHECK (p. 72)
- ASSIGN3: PICTURE PROFILE (p. 53)
- ASSIGN4: FOCUS MAGNIFIER (p. 35)
- ASSIGN5: IRIS PUSH AUTO (p. 39)
- ASSIGN6: D. EXTENDER (p. 87)

## Functions you can assign to the ASSIGN buttons

- - (no function)
- FOCUS MAGNIFIER (p. 35)
- LAST SCENE REVIEW (p. 63)
- WHT BAL (p. 42)
- WB PRESET (p. 86)
- WB SET (p. 87)
- AE SHIFT (p. 87)
- D.EXTENDER (p. 87)
- STEADY SHOT (p. 88)
- S&Q MOTION (p. 61)
- AUTO MODE SET (p. 88)
- SCENE SELECTION SET (p. 88)
- NIGHTSHOT (p. 48)
- IRIS PUSH AUTO (p. 39)
- SPOT METER/FOCUS (p. 88)
- SPOT METER (p. 88)
- SPOT FOCUS (p. 88)
- FACE DETECTION (p. 88)
- COLOR BAR (p. 89)
- PICTURE PROFILE (p. 53)
- VOLUME (p. 92)
- HISTOGRAM (p. 93)
- ZEBRA (p. 94)
- PEAKING (p. 94)

- MARKER (p. 94)
- CAMERA DATA DISPLAY (p. 95)
- AUDIO LEVEL DISPLAY (p. 95)
- DATA CODE (p. 96)
- TC/UB DISPLAY (p. 97)
- SMARTPHONE CONNECT (p. 50)
- STATUS CHECK (p. 72)
- REC LAMP (p. 101)
- THUMBNAIL (p. 66)

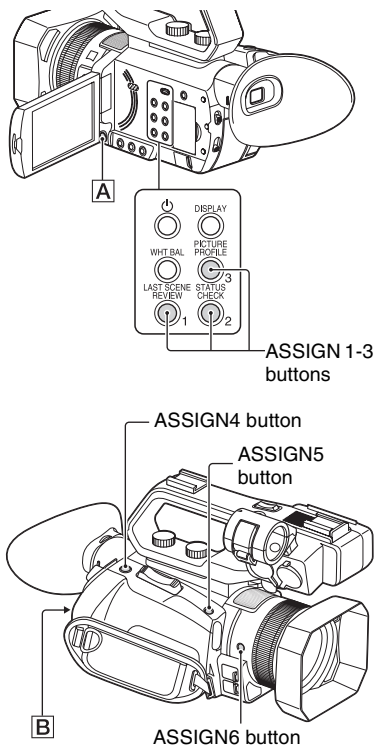

**1** Press the MENU button **A**.

- 
- 2** Select **[OTHERS]** → **[ASSIGN BUTTON]** with the **▲/▼/◀/▶/EXEC** button **[B]**.

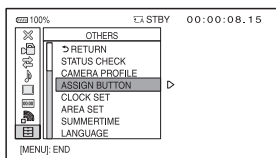

- 
- 3** Press the **▲/▼/◀/▶/EXEC** button **[B]**, select the **ASSIGN** button that you want to set, then press the button again.

- 
- 4** Press the **▲/▼/◀/▶/EXEC** button **[B]**, select the function that you want to assign, then press the button again.

- 
- 5** Press the **▲/▼/◀/▶/EXEC** button **[B]**, select **[OK]**, then press the button again.
-

# Playback

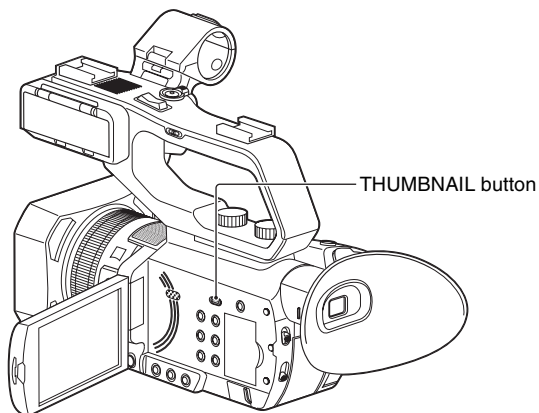

## Playing back movies

- 1 Open the LCD panel.

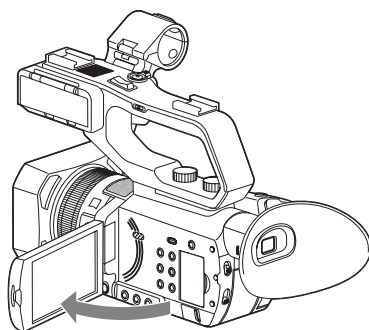

## 2 Press the THUMBNAIL button.

The THUMBNAIL screen appears after a few seconds.

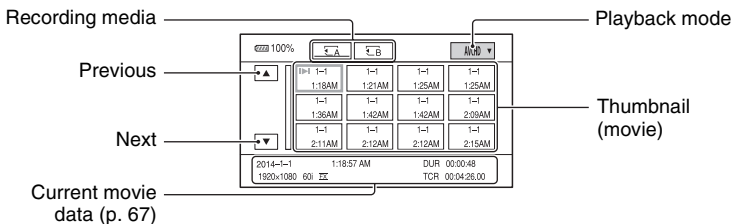

- You can turn on or off the date and time display on the thumbnails by pressing the DISPLAY button.

## 3 Play back movies.

- 1 Touch the recording media you want to play back.  
You can also select the desired recording media by pressing the ▲/▼/◀/▶/EXEC button followed by pressing the EXEC button.

◀A : Memory card A

◀B : Memory card B

- 2 Touch the playback mode, and select the desired image quality of movies.

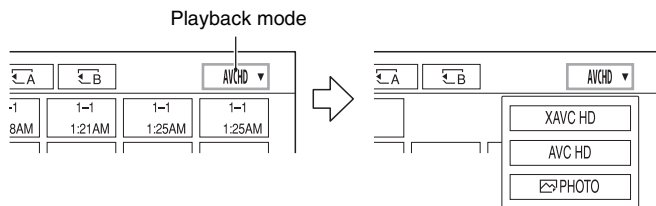

- 3 Touch twice the thumbnail of the movie you want to play back.  
You can also select the movie to be played back by pressing ▲/▼/◀/▶ buttons followed by pressing the EXEC button.

The first touch of the thumbnail will show the information on the movie at the lower part of the LCD screen.

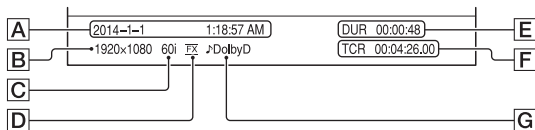

[A] Date and time of recording started

[B] Resolution

## Playback (Continued)

**C** Frame rate

**D** Recording mode

**E** Duration

**F** Time code of recording started

Time code will not be displayed correctly when you play back recording media with no time code, or recording media with time code that your camcorder does not support.

**G** DOLBY DIGITAL recording

Displayed when audio is recorded in Dolby Digital format.

- **▶|** appears with the movie that has been most recently played back or recorded. If you touch the movie with **▶|**, you can continue playback from the previous time.

Your camcorder starts playing the selected movie.

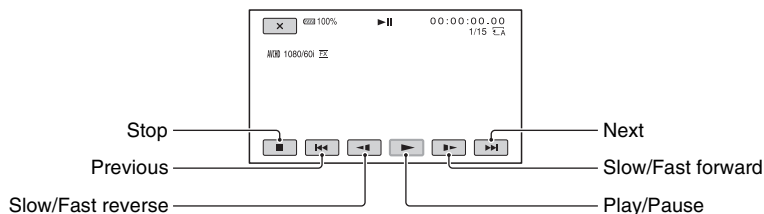

### Notes

- Movie files recorded in DV mode can only be played back when the camcorder is set to DV mode.

### Tips

- When playback from the selected movie reaches the last movie, the screen returns to the THUMBNAIL screen.
- Touch **◀|/▶** during pause to play back movies slowly.
- The playback speed increases based on the number of times that you touch **⏏/⏏**.
- In DV mode, SCAN/SLOW buttons are disabled.
- In DV mode, fast forward and fast reverse during playback are 5 times faster than normal playback speed.
- When you play back a DV file recorded with a camcorder other than this camcorder, the F value may not be displayed correctly.

### To adjust the volume

Press the MENU button and select **🎵** (AUDIO SET) → [VOLUME] to adjust the volume.

### To return to the recording mode

Press the THUMBNAIL button.



## On playing back movies

- Movies recorded using this camcorder may not be played back normally on devices other than this camcorder. Also, movies recorded on other devices may not play back properly on this camcorder.
- DV movies recorded on SD memory cards cannot be played on A/V devices of other manufacturers.

## Playing back still images

### 1 Touch the recording media you want to view on the THUMBNAIL screen.

⏪ A : Memory card A

⏪ B : Memory card B

### 2 Touch the playback mode, then select (still image).

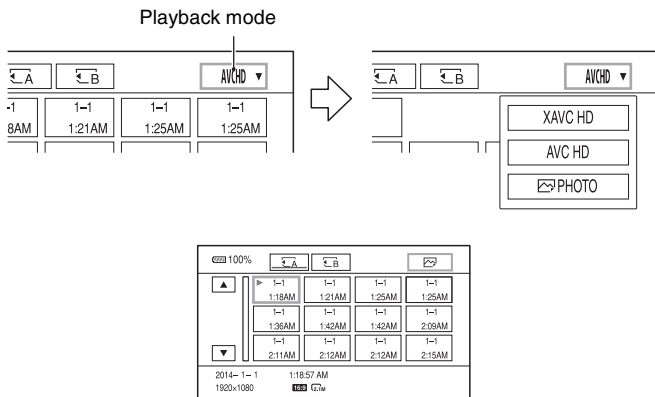

### 3 Touch twice the thumbnail of the still image you want to view.

The first touch of the thumbnail will show the information on the still image at the lower part of the LCD screen.

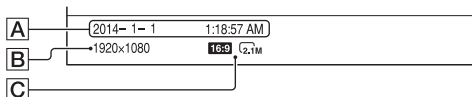

**A** Date and time of recording

**B** Resolution

**C** Image size

## Playback (Continued)

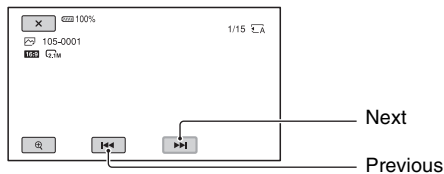

Your camcorder displays the selected still image.



---

### To enlarge

Touch  (playback zoom) when playing back a still image.

You can adjust the zoom with  / , or with the power zoom lever.

When you touch the enlarged image, the touched point will be displayed at the center of the screen.

### Notes on playing back still images

- The camcorder is not able to record still images, but it can play back still images that were recorded on another device.
- The camcorder may not be able to play back some still images.

# Changing/checking the settings in your camcorder

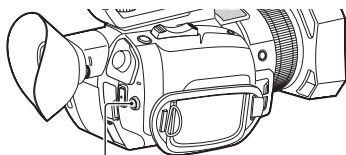
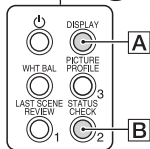
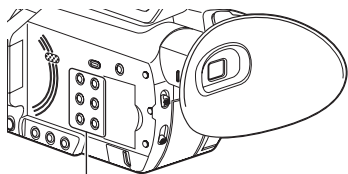

## Changing the screen display

You can display information such as time code, etc., on the image.

**Press the DISPLAY button (A).**

The screen indicators turn on (displayed) and off (not displayed) as you press the button.

In the recording mode, the screen changes in the order, detailed display → simple display → no display with each press of the button.

### 💡 Tips

- You can display the screen indicators during playback on a TV. Select [ALL OUTPUT] of [DISPLAY OUTPUT] (p. 97).

## Displaying recording data (Data code)

You can display information, including date, time and camera data automatically stored during recording on the screen during playback.

Select **DISPLAY SET** → **DATA CODE** and choose the data that you want to display, or press the **ASSIGN** button to which the **DATA CODE** function is assigned, during playback or pause.

The screen changes in the order, date and time display → camera data display → no display with each press of the button.

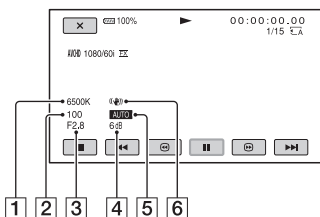

- 1 White balance  
**PWB** will appear during the playback of still images or movies recorded with [MANU WB TEMP].
- 2 Shutter speed
- 3 Iris
- 4 Gain
- 5 Exposure  
**AUTO** appears during playback of the movie recorded with the iris, gain or shutter speed automatically adjusted.  
**MANUAL** appears during playback of the movie recorded with the iris, gain or shutter speed manually adjusted.
- 6 SteadyShot

## Changing/checking the settings in your camcorder (Continued)

### Notes

- When you play back the memory card on other devices, the camera data may be displayed incorrectly. Confirm the correct camera data on your camcorder.
- Data code cannot be displayed for XAVC HD.

## Checking the settings in your camcorder (Status check)

You can check the settings of the following items.

- [STATUS CHECK] is assigned to the ASSIGN2 button (p. 64).
  - Audio setup (p. 92)
  - Output signal setup (p. 90)
  - Functions assigned to the ASSIGN buttons (p. 64)
  - Camera setup (p. 86)
  - Record button setup (p. 32)
- You can check the record button setting.

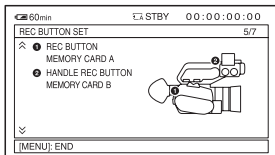

- Recording media information  
You can check the estimated used and free spaces.

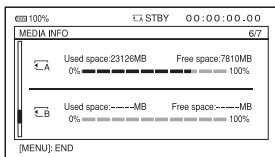

- Battery Info  
You can check the remaining capacity of the attached battery.

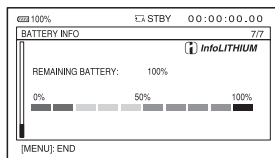

### 1 Press the ASSIGN2 button [B].

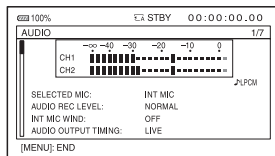

### 2 Press the ▲/▼/◀/▶/EXEC button [C] to display the items.

AUDIO → OUTPUT → ASSIGN →  
CAMERA → REC BUTTON SET →  
MEDIA INFO → BATTERY INFO

Setup items are displayed according to the settings of the camcorder when it is turned on.

### To hide the display

Press the ASSIGN2 button [B].

# Connecting a monitor or a TV

Playback image quality depends on the type of monitor or TV, or the jacks used to make the connection.

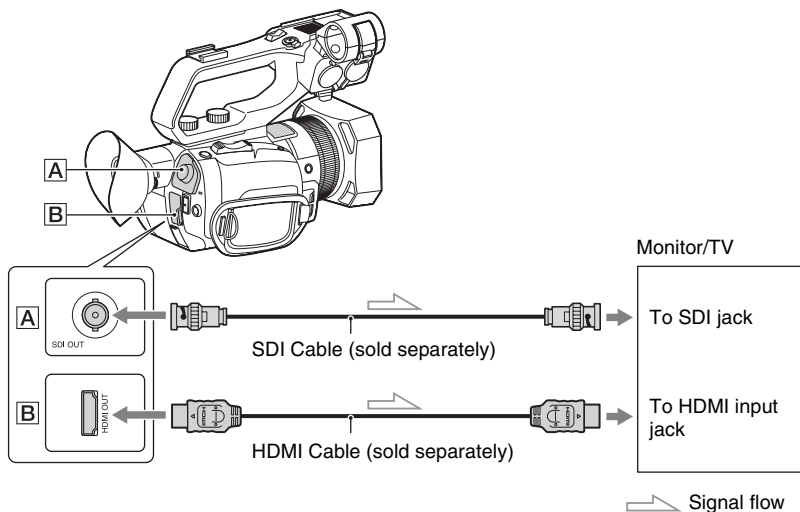

Playback

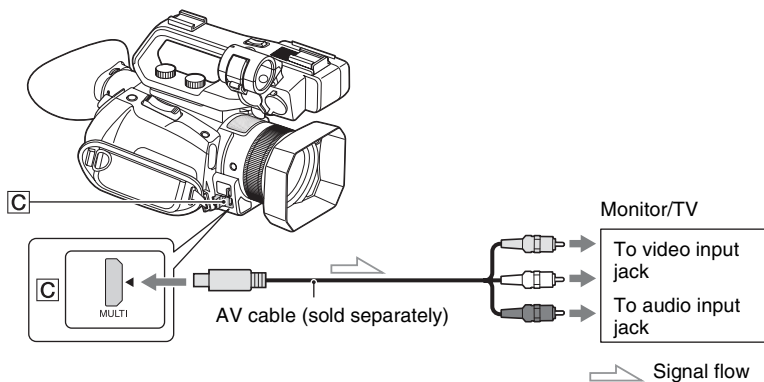

**1** Press the MENU button.

## Connecting a monitor or a TV (Continued)

**2** Press the **▲/▼/◀/▶/EXEC** button to select **↔ (REC/OUT SET) → [OUTPUT SELECT] → the jack that you want to use for output.**

The VIDEO OUT and AUDIO OUT jacks are integrated into the Multi/Micro USB jack. To connect to the video input or audio input jack of a monitor or TV, use an AV cable (sold separately).

Image signals cannot to be output from HDMI OUT, VIDEO OUT, and SDI OUT jacks simultaneously.

The output resolution of the VIDEO OUT is 480i when [60i/50i SEL] is set to 60i, or 576i when [60i/50i SEL] is set to 50i.

### Output resolution

The output resolution varies depending on the recording mode and [SDI/HDMI] setting.

#### When [60i] is selected

HD/DV	[SDI/HDMI] setting	Output resolution		
		SDI OUT	HDMI OUT	VIDEO OUT
HD	1080p/480i	1080p	1080p*	480i
	720p/480i	720p	720p	480i
	1080i/480i	1080i	1080i	480i
	480p	No output	480p	480i
	480i	480i	480i	480i
DV	1080p/480i	480i	480i	480i
	720p/480i	480i	480i	480i
	1080i/480i	480i	480i	480i
	480p	No output	480p	480i
	480i	480i	480i	480i

#### When [50i] is selected

HD/DV	[SDI/HDMI] setting	Output resolution		
		SDI OUT	HDMI OUT	VIDEO OUT
HD	1080p/576i	1080p	1080p*	576i
	720p/576i	720p	720p	576i
	1080i/576i	1080i	1080i	576i
	576p	No output	576p	576i
	576i	576i	576i	576i

HD/DV	[SDI/HDMI] setting	Output resolution		
		SDI OUT	HDMI OUT	VIDEO OUT
DV	1080p/576i	576i	576i	576i
	720p/576i	576i	576i	576i
	1080i/576i	576i	576i	576i
	576p	No output	576p	576i
	576i	576i	576i	576i

\* For movies recorded with the frame rate in [REC FORMAT] set to 24p, the output resolution varies depending on the [24p OUTPUT] setting in [VIDEO OUT], as shown below.

24p OUTPUT	Output resolution	
	SDI OUT	HDMI OUT
24p	1080/24p	1080/24p
60p	1080/60p	1080/60p

### 🔊 Notes

- It is recommended that you use an authorized cable with HDMI logo or a Sony HDMI cable.
- Images are not output from the HDMI OUT jack of your camcorder, if copyright protection signals are recorded in the movies.
- Images and sounds may not be reproduced correctly on some monitors or TVs.
- Do not connect the output jacks of the camcorder with the output jacks of the monitor or TV. A malfunction may be caused.
- When the frame rate in [REC FORMAT] is set to 24p or 30p (when [60i] is selected) or 25p (when [50i] is selected), the output signal is converted to interlace or progressive through pull-down conversion.
- If you display the edit screen while outputting signals to a monitor or TV, the menu may not be displayed correctly.
- This camcorder is not compatible with “BRAVIA” sync.

### 💡 Tips

- HDMI (High-Definition Multimedia Interface) is an interface for transferring uncompressed digital audio and video signals between a TV and a connected device. By connecting a cable from the camcorder's HDMI OUT jack to your TV, you can enjoy high image quality video and digital audio.

## Protecting movies and still images (Protect)

Protect movies and still images to avoid deleting them by mistake.

**1** Press the MENU button when the THUMBNAIL screen is displayed.



**2** Press the ▲/▼/◀/▶/EXEC button, then select  (EDIT) → [PROTECT].

**3** Touch the movies or still images to be protected.

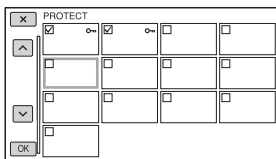
✓ is displayed on the selected images.



- Press and hold the image down to preview the image. Touch  to return to the previous screen.
- You can select up to 100 images at one time.

**4** Touch  →  → .

### To undo the protection of movies and still images

Touch the movie or still image marked with ✓ in step 3.  
✓ disappears.

#### Notes

- You cannot protect DV images.

## Dividing a movie

You can divide a movie at a designated point.

**1** Press the MENU button while playing back movies.

**2** Press the ▲/▼/◀/▶/EXEC button, then select  (EDIT) → [DIVIDE].

**3** Touch  at the point where you want to divide.

After you select the point with , make fine adjustment with these buttons.

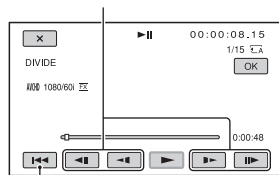

Returns to the beginning of the selected movie.

**4** Touch  → .

#### Notes

- You cannot restore movies once they are divided.
- Do not remove the battery pack, the AC Adaptor or the recording media that contains the movies from your camcorder during the operation. It may damage the recording media.
- A slight difference may occur from the point where you touch  and the actual dividing point, as your camcorder selects the dividing point based in about half-second increments.
- Movies recorded in DV or XAVC HD cannot be divided.



# Deleting movies and still images

You can free media space by deleting movies and still images from recording media.

## Notes

- You cannot restore images once they are deleted.
- Do not remove the battery pack, the AC Adaptor or the recording media that contains the movies or still images from your camcorder during the operation. It may damage the recording media.
- You cannot delete protected movies and still images. Undo the protection of the movies and still images, before you try to delete them (p. 76).
- Save important movies and still images in advance.

## Tips

- To delete all data recorded on the recording media and recover all the recordable space of the media, format the media (p. 78).

---

**1 Press the MENU button when the THUMBNAIL screen is displayed.**

---



**2 Press the ▲/▼/◀/▶/EXEC button, then select  (EDIT) → [DELETE].**

---

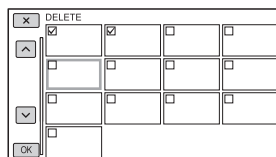

**3 Touch the movies or still images to be deleted.**

✓ is displayed on the selected images.



- Press and hold the image down to preview the image. Touch  to return to the previous screen.
- You can select up to 100 images at one time.
-  appears at the upper right corner on the thumbnail of protected images.
- No check box appears on the thumbnail of protected images.

---

**4 Touch  →  → .**

---

# Formatting the recording media

Formatting deletes data from the recording media to recover recordable free space.

## Notes

- Connect your camcorder to the wall outlet (wall socket) using the supplied AC Adaptor to prevent your camcorder from running out of power during the operation.
- To avoid the loss of important images, you should save them before formatting the recording media.
- Protected movies and still images are also deleted.

---

**1** Press the MENU button.

---

**2** Press the ▲/▼/◀/▶/EXEC button, then select  (OTHERS) → [MEDIA FORMAT].

---

**3** Select the recording media to be formatted.

---

**4** Touch  → .

## Notes

- While [Executing...] is displayed, do not turn off the camcorder, do not operate any buttons on the camcorder, disconnect the AC Adaptor, or remove the recording media from your camcorder. (The access lamp is lit or flashing while formatting recording media.)

# Deleting all data from the memory card completely

If a memory card is used repeatedly, garbage data accumulate which may prevent the image data from being written at the fixed speed. In this case, recording may stop suddenly.

If this happens, empty the memory card to avoid the writing error. Emptying the memory card can erase more data than ordinary formatting.

## 🔊 Notes

- If you perform this operation, all stored data are deleted. To avoid the loss of important images, you should save them before the operation.
- You cannot perform this operation unless you connect the AC Adaptor to the wall outlet (wall socket).
- Disconnect all cables except the AC Adaptor. Do not disconnect the AC Adaptor during the operation.
- Do not apply any vibrations or shocks to your camcorder during this operation.

---

**1** Connect your camcorder to the wall outlet (wall socket) using the AC Adaptor AC-L200D (supplied) (p. 21).

---

**2** Press the MENU button.

---

**3** Press the ▲/▼/◀/▶/EXEC button, then select  (OTHERS) → [MEDIA FORMAT].

---

**4** Select the recording media to be formatted.

The format screen appears.

---

**5** Touch [Empty] → .

---

## 🔊 Notes

- It may take from several minutes to several hours to empty recording media, depending on the capacity. You can check the actual time required on the LCD screen.
- If you stop the operation while [Executing...] is displayed, be sure to complete the operation by performing [MEDIA FORMAT] or emptying before you use the recording media next time.

## 💡 Tips

- To prevent a data write error from occurring on the recording media, empty the media data from the camcorder before you start recording. By deleting all data using the [Empty] operation instead of the ordinary [MEDIA FORMAT] operation, you can minimize potential media write errors that might occur when recording.

# Repairing the image database file

This function checks the database information and the consistency of movies and still images on the recording media, and repairs if any inconsistencies found.

## 🔔 Notes

- Connect your camcorder to the wall outlet (wall socket) using the supplied AC Adaptor to prevent your camcorder from running out of power during the operation.

---

**1** Press the MENU button.

---

**2** Turn the ▲/▼/◀/▶/EXEC button to select  (OTHERS) → [REPAIR IMAGE DB FILE].

---

**3** Select the recording media you want to check the database file.

---

**4** Touch .

The database file check starts. Touch  and quit the database file check if no inconsistency is found.

---

**5** Touch  → .

## 🔔 Notes

- If you stop the operation while [Repairing the image database file.] is displayed, be sure to complete the operation as described above before you use the recording media next time.

# Operating the menu

You can change various settings or make detailed adjustments using the menu items displayed on the LCD screen.

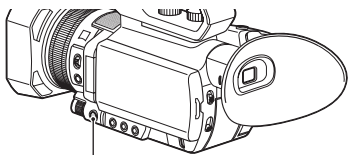

MENU button

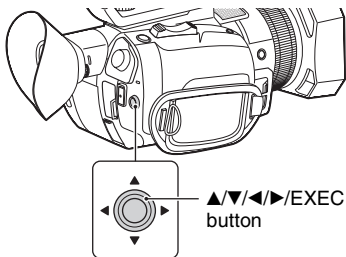
 ▲▼/◀▶/EXEC  
button

## 1 Press the MENU button.

The menu screen appears.

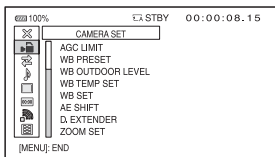

## 2 Press the ▲▼/◀▶/EXEC button, select the desired menu icon, then press the button again.

- ☰ CAMERA SET (p. 86)
- ↔ REC/OUT SET (p. 90)
- ♪ AUDIO SET (p. 92)
- DISPLAY SET (p. 93)
- 00:00 TC/UB SET (p. 97)
- 📶 NETWORK SET (p. 99)
- ☰ OTHERS (p. 100)
- 👉 EDIT (p. 86)

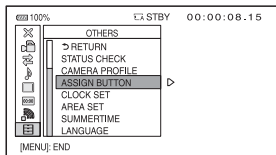

## 3 Press the ▲▼/◀▶/EXEC button, select the item that you want to set, then press the button again.

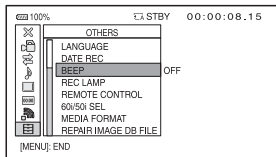

- 4** Press the ▲/▼/◀/▶/EXEC button, select the desired setting, then press the button again.

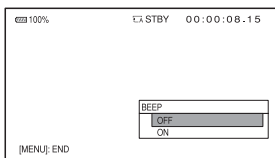

- 5** Press the MENU button to hide the menu screen.

To return to the previous screen, select [↩ RETURN].

---

### 🔍 Notes

- The available menu items vary depending on the context of your camcorder during recording or playback.
- Items and setting values not available due to other settings, are grayed out.

# Menu items

The function and setting value of each menu item are as follows.  
The default settings are marked with ►.

## (CAMERA SET) (p. 86)

AGC LIMIT	►OFF, 24dB - 9dB
WB PRESET	►OUTDOOR, INDOOR, MANU WB TEMP
WB OUTDOOR LEVEL	-7 - +7 (►0)
WB TEMP SET	2300K - 15000K (►6500K)
WB SET	
AE SHIFT	ON/OFF ►OFF, ON  LEVEL -2.0EV - +2.0EV (►0EV)
D.EXTENDER	►OFF, ON
ZOOM SET	ZOOM TYPE ►OPTICAL ZOOM ONLY, ON[CLEAR IMAGE ZOOM], ON[DIGITAL ZOOM]  HANDLE ZOOM 1 - 8 (►3)  SPEED ZOOM ►OFF, ON
 STEADY SHOT	►STANDARD, ACTIVE, OFF
S&Q MOTION	[XAVC HD] REC FORMAT When [60i] is selected 1080/60p 50Mbps, 1080/60p 35Mbps, 1080/30p 50Mbps, 1080/30p 35Mbps, ►1080/24p 50Mbps, 1080/24p 35Mbps, When [50i] is selected 1080/50p 50Mbps, 1080/50p 35Mbps, ►1080/25p 50Mbps, 1080/25p 35Mbps,

FRAME RATE  
1-60fps  
(►60fps)

[AVCHD]  
REC FORMAT  
When [60i] is  
selected  
1080/60p PS,  
1080/30p FX,  
1080/30p FH,  
►1080/24p FX,  
1080/24p FH,  
When [50i] is  
selected  
1080/50p PS,  
►1080/25p FX,  
1080/25p FH,

FRAME RATE  
1-60fps  
(►60fps)

AUTO MODE SET	►AUTO, INTELLIGENT AUTO, SCENE SELECTION
SCENE SELECTION SET	NIGHT SCENE, SUNRISE & SUNSET, FIREWORKS, LANDSCAPE, ►PORTRAIT, SPOTLIGHT, BEACH
SPOT METER/ FOCUS	
SPOT METER	
SPOT FOCUS	
AUTO SLOW SHUTTER	►OFF, ON
AUTO BACK LIGHT	►OFF, ON
FACE DETECTION	►OFF, ON
NIGHTSHOT LIGHT	►ON, OFF
COLOR BAR	ON/OFF ►OFF, ON TONE ►OFF, ON
PICTURE PROFILE	See page 53.



## (REC/OUT SET) (p. 90)

### REC SET

#### FILE FORMAT

- ▶XAVC HD, AVCHD

#### REC FORMAT

##### XAVC HD

When [60i] is selected

- 1080/60p 50Mbps,
- 1080/60p 35Mbps,
- ▶1080/60i 50Mbps,
- 1080/60i 35Mbps,
- 1080/60i 25Mbps,
- 1080/30p 50Mbps,
- 1080/30p 35Mbps,
- 1080/24p 50Mbps,
- 1080/24p 35Mbps,
- 720/60p 50Mbps

When [50i] is selected

- 1080/50p 50Mbps,
- 1080/50p 35Mbps,
- ▶1080/50i 50Mbps,
- 1080/50i 35Mbps,
- 1080/50i 25Mbps,
- 1080/25p 50Mbps,
- 1080/25p 35Mbps,
- 720/50p 50Mbps

##### AVCHD

When [60i] is selected

- 1080/60p PS,
- ▶1080/60i FX,
- 1080/60i FH,
- 1080/30p FX,
- 1080/30p FH,
- 1080/24p FX,
- 1080/24p FH,
- 720/60p FX,
- 720/60p FH,
- 720/60p HQ

When [50i] is selected

- 1080/50p PS,
- ▶1080/50i FX,
- 1080/50i FH,
- 1080/25p FX,
- 1080/25p FH,
- 720/50p FX,

- 720/50p FH,
- 720/50p HQ

### SIMUL/RELAY REC

- ▶OFF,
- SIMULTANEOUS REC, RELAY REC

### REC BUTTON SETTING

- ▶REC BUTTON:

$\overline{\text{A}}$   $\overline{\text{B}}$ ,  
HANDLE REC  
BUTTON:  $\overline{\text{A}}$

$\overline{\text{B}}$  / REC  
BUTTON:  $\overline{\text{A}}$ ,

HANDLE REC  
BUTTON:  $\overline{\text{B}}$  /

REC BUTTON:  
 $\overline{\text{B}}$ , HANDLE REC  
BUTTON:  $\overline{\text{A}}$

### DV MODE

#### $\overline{\text{DV}}$ WIDE REC

- ▶OFF, ON

### CANCEL DV MODE

### VIDEO OUT

#### OUTPUT SELECT

- SDI, ▶HDMI, VIDEO

#### SDI/HDMI

When [60i] is selected  
1080p/480i, 720p/  
480i, ▶1080i/480i,  
480p, 480i

When [50i] is selected  
1080p/576i, 720p/  
576i, ▶1080i/576i,  
576p, 576i

#### 24p OUTPUT\*1

- 24p, ▶60p

#### DOWN CONVERT TYPE

- ▶SQUEEZE,
- LETTER BOX(16:9),
- EDGE CROP

#### $\overline{\text{DV}}$ WIDE CONVERT

- ▶SQUEEZE,
- LETTER BOX(16:9),
- EDGE CROP



HDMI TC OUTPUT  
▶OFF, ON  
SDI/HDMI REC  
CONTROL  
▶OFF, ON

ASPECT  
▶OFF, 4:3, 13:9,  
14:9, 15:9, 1.66:1,  
1.85:1, 2.35:1

SAFETY ZONE  
▶OFF, 80%, 90%

GUIDEFAME  
▶OFF, ON

## (AUDIO SET) (p. 92)

VOLUME  
AVCHD AUDIO ▶LINEAR PCM,  
FORMAT DOLBY DIGITAL  
AUDIO REC LEVEL REC LEVEL MODE  
▶NORMAL, HIGH,  
MANUAL  
MANUAL REC LEVEL  
1 - 31 (▶21)  
INT MIC WIND ▶OFF, ON  
MIC SELECT ▶AUTO, INT MIC, MI  
SHOE MIC, STEREO  
MINI MIC  
AUDIO OUTPUT ▶LIVE, LIP SYNC  
TIMING

FOCUS MAG RATIO x4.0, x8.0, ▶x4.0/x8.0  
CAMERA DATA OFF, ▶ON  
DISPLAY  
AUDIO LEVEL ▶ON, OFF  
DISPLAY  
ZOOM DISPLAY ▶BAR, NUMBER  
FOCUS DISPLAY ▶METER, FEET  
SHUTTER DISPLAY ▶SECOND, DEGREE  
DATA CODE ▶OFF, DATE/TIME,  
CAMERA DATA  
LCD BRIGHT ▶NORMAL, BRIGHT  
VF BRIGHT ▶NORMAL, BRIGHT  
VF COLOR TEMP.  
DISPLAY OUTPUT ▶LCD PANEL,  
ALL OUTPUT

## (DISPLAY SET) (p. 93)

HISTOGRAM ▶OFF, ON,  
ON[ZEBRA POINT]  
ZEBRA ON/OFF  
▶OFF, ON  
LEVEL  
70 - 100, 100+  
(▶70)  
PEAKING ON/OFF  
▶OFF, ON  
COLOR  
▶WHITE, RED,  
YELLOW  
LEVEL  
HIGH, ▶MIDDLE,  
LOW  
MARKER ON/OFF  
▶OFF, ON  
CENTER  
▶ON, OFF

### Tips

- You can display [DATA CODE] by pressing the MENU button when the playback screen is displayed.

## (TC/UB SET) (p. 97)

TC/UB DISPLAY ▶TC, U-BIT  
TC PRESET PRESET, RESET  
UB PRESET PRESET, RESET  
TC FORMAT\*1 ▶DF, NDF  
TC RUN ▶REC RUN,  
FREE RUN  
TC MAKE ▶PRESET,  
REGENERATE  
UB TIME REC ▶OFF, ON

## (NETWORK SET) (p. 99)

CTRL W/  
SMARTPHONE  
AIRPLANE MODE ▶OFF, ON  
EDIT DEVICE NAME  
DISP MAC ADDRESS

## Menu items (Continued)

SSID/PW RESET



### (OTHERS)

(p. 100)

STATUS CHECK

CAMERA PROFILE MEMORY CARD A,  
MEMORY CARD B

ASSIGN BUTTON ASSIGN1, ASSIGN2,  
ASSIGN3, ASSIGN4,  
ASSIGN5, ASSIGN6

CLOCK SET

AREA SET

SUMMERTIME ►OFF, ON

LANGUAGE

DATE REC ►OFF, ON

BEEP ►OFF, ON

REC LAMP ►ON, OFF

REMOTE CONTROL ►ON, OFF

60i/50i SEL 60i, 50i\*2

MEDIA FORMAT MEMORY CARD A,  
MEMORY CARD B

REPAIR IMAGE DB MEMORY CARD A,  
MEMORY CARD B

USB CONNECT

USB LUN SET ►MULTI, SINGLE

OPERATION TIME

VERSION DISPLAY

CALIBRATION

INITIALIZE



### (EDIT)

PROTECT

DIVIDE

DELETE

### 💡 Tips

- You can display the [EDIT] menu by pressing the MENU button when the THUMBNAIL or playback screen is displayed.

\*1 Settings are available only when [60i/50i SEL] is set to [60i].

\*2 The default setting is 60i for NTSC and 50i for PAL. Refer to the label on the bottom of the set.

## (CAMERA SET) menu

Settings to adjust your camcorder to the recording conditions ( STEADY SHOT, etc.)

The default settings are marked with ►.

See page 81 for details on selecting menu items.

Press the MENU button → select  (CAMERA SET) with the ▲/▼/◀/▶/EXEC button.

### AGC LIMIT

You can select the upper limit for the Auto Gain Control (AGC).

►OFF, 24dB - 9dB (3dB increments)

### 📌 Notes

- This function is not effective while you adjust the gain manually.

### WB PRESET

You can use the preset white balance. For more details, see page 42.

### WB OUTDOOR LEVEL

You can set an offset value to adjust the outdoor white balance when you set [WB PRESET] to [OUTDOOR].

-7 - ►0 - +7  
(bluish - normal - reddish)

### WB TEMP SET

You can set the color temperature when you set [WB PRESET] to [MANU WB TEMP].

2300K - ►6500K - 15000K (100K increments)

## WB SET

See page 43.

## AE SHIFT

### ■ ON/OFF

#### ▶ OFF

Does not use the AE SHIFT function.

#### ON

Uses the AE SHIFT function. The selected value (-2.0EV for example) appears on the LCD screen.

### ■ LEVEL

You can set an offset value to adjust the automatic exposure adjustment value with the ▲/▼/◀/▶/EXEC button.

**-2.0EV - ▶0EV - +2.0EV**  
(dark - standard - bright)

### 🔌 Notes

- This function is not effective while you adjust the iris, shutter speed, gain all manually.

### 💡 Tips

- You can assign [ON/OFF] to an ASSIGN button (p. 64).

## D. EXTENDER

You can use 2× magnification when recording.

#### ▶ OFF

Does not use the magnification function.

#### ON (DIG.EXT)

Uses the magnification function.

### 💡 Tips

- [D.EXTENDER] is assigned to the ASSIGN6 button (p. 64).

## ZOOM SET

### ■ ZOOM TYPE

#### ▶ OPTICAL ZOOM ONLY

Uses only optical zoom. You can zoom up to 12×.

#### ON[CLEAR IMAGE ZOOM]

You can use the clear image zoom in addition to the optical zoom.

You can zoom up to 24×, which includes 12× optical zoom.

#### ON[DIGITAL ZOOM]

You can use the digital zoom in addition to the optical zoom and clear image zoom.

You can zoom up to 192× but the image quality deteriorates within the range where  $\text{DQ}$  is displayed.

### 💡 Tips

- Clear image zoom maintains an image quality that is close to the original.
- The face detection function will not be effective while using the digital zoom.

### ■ HANDLE ZOOM

You can select the zoom speed for the FIX position of the handle zoom switch.

**1 - ▶3 - 8**

(slow - normal - fast)

### ■ SPEED ZOOM

You can increase the zoom speed of the power zoom lever and the handle zoom.

#### ▶ OFF

#### ON

### 🔌 Notes

- When you set this function to [ON], the operation sound of the zoom may also be recorded at the movie recording.

Press the MENU button → select  (CAMERA SET) with the ▲/▼/◀/▶/EXEC button.

## STEADY SHOT

You can set the camera shake reduction when shooting.

### ▶ STANDARD ( )

Uses SteadyShot when shooting under relatively stable conditions.

### ACTIVE ( )

Uses SteadyShot with more powerful effect.

### OFF ( )

Does not use SteadyShot.

This setting is recommended when you use a tripod.

### 🔊 Notes

- When [ACTIVE] is selected, the angle of view shifts 1.08 times toward the telephoto side.

### 💡 Tips

- You can assign this function to an ASSIGN button (p. 64).

## S&Q MOTION

See page 61.

## AUTO MODE SET

See page 47.

## SCENE SELECTION SET

See page 47.

## SPOT METER/FOCUS

You can adjust the brightness and focus for the selected subject automatically.

### 💡 Tips

- Automatic brightness adjustment can be canceled by setting the AUTO/MANUAL switch to AUTO.

## SPOT METER

You can adjust the brightness for the selected subject automatically.

### 💡 Tips

- Automatic brightness adjustment can be canceled by setting the AUTO/MANUAL switch to AUTO.

## SPOT FOCUS

See page 35.

## AUTO SLOW SHUTTER

You can set the shutter speed to slow down automatically up to 1/30 (up to 1/24 when shooting in 24p) (when [60i] is selected) or up to 1/25 (when [50i] is selected) when recording in a dark place.

### ▶ OFF

Does not use the AUTO SLOW SHUTTER function.

### ON ( )

Uses the AUTO SLOW SHUTTER function.

## AUTO BACK LIGHT

You can automatically correct for backlighting.

### ▶ OFF

Does not correct for backlighting.

### ON

Automatically corrects for backlighting.

## FACE DETECTION

See page 35.

## NIGHTSHOT LIGHT

You can record clear images with NIGHTSHOT (p. 48), which uses an infrared light when shooting.

### ▶ ON

Emits infrared light.

### OFF

Does not emit infrared light.

### 🔌 Notes

- Make sure that your finger does not cover the infrared light emitter (p. 4) when shooting.
- Remove the lens hood (supplied) so that they do not block the infrared light emitter.
- The light is effective up to a distance of approximately 3 meters.

## COLOR BAR

### ■ ON/OFF

### ▶ OFF

Does not display color bars.

### ON

Displays color bars on the LCD screen, records them on recording media, and outputs audio tone signals.

This function helps you to adjust colors when you view movies recorded with your camcorder on a TV or a monitor.

### 🔌 Notes

- This function is automatically set to [OFF] when you switch the format, perform the function by the MENU button, or turn off the camcorder.
- You cannot change the setting during recording or the Focus Magnifier operation.

## ■ TONE

### ▶ OFF

Does not output audio tone signals.

### ON

Outputs audio tone signals (1 kHz: full bit -20dB (when [60i] is selected), -18dB (when [50i] is selected)).

Set [ON/OFF] to [ON], too.

### 💡 Tips

- You can assign [ON/OFF] to an ASSIGN button (p. 64).
- If you record color bars with [TONE] set to [OFF], the camcorder records sound from the microphone.

## PICTURE PROFILE

See page 53.

# ⇄ (REC/OUT SET) menu

Recording settings, input and output settings (REC SET/VIDEO OUT, etc.)

The default settings are marked with ▶.

See page 81 for details on selecting menu items.

Press the MENU button → select  
⇄ (REC/OUT SET) with the ▲/▼/◀/▶/  
EXEC button.

## REC SET

### ■ REC FORMAT

See page 37.

### ■ SIMUL/RELAY REC

See page 31.

### ■ REC BUTTON SET

See page 32.

### ■ DV MODE

See page 38.

### ■ WIDE REC

You can set the aspect ratio when recording in DV.

#### ▶ OFF (4:3)

Records in 4:3.

#### ON

Records in 16:9.

### Notes

- When recording at a setting other than DV, the aspect ratio is fixed to 16:9, and the 4:3 aspect ratio is not available.

### ■ CANCEL DV MODE

See page 38.

## VIDEO OUT

### ■ OUTPUT SELECT

You can select the jack to use for video output.

#### SDI

Outputs from SDI jack.

### ▶ HDMI

Outputs from HDMI jack.

### VIDEO

Outputs from VIDEO jack.

### ■ SDI/HDMI

You can select the resolution of the output signal from the HDMI/SDI jacks.

When [60i] is selected:

1080p/480i

720p/480i

### ▶ 1080i/480i

480p

480i

When [50i] is selected:

1080p/576i

720p/576i

### ▶ 1080i/576i

576p

576i

### Tips

- See page 74 on the output resolution of the signal for each connecting cable.

### ■ 24p OUTPUT (when [60i] is selected)

You can set the output format when the frame rate in [REC FORMAT] is set to 24p.

24p

Outputs in 24p.

### ▶ 60p

Outputs in 60p.

### Notes

- This function is available only when SDI/HDMI is 1080p/480i.

## ■ DOWN CONVERT TYPE

You can select a down convert type when you down-convert video signal. Use this function for outputting movies and still images recorded in 16:9.

### ► SQUEEZE

Outputs a horizontally compressed image while maintaining its original height.

### LETTER BOX(16:9)

Outputs a vertically compressed image while maintaining its original aspect ratio.

### EDGE CROP

Outputs the central portion of the original image by cropping its right and left edges.

## ■ WIDE CONVERT

You can select a down convert type when you down-convert video signal. Use this function for outputting DV movies recorded with [ WIDE REC] set to [ON].

### ► SQUEEZE

Outputs a horizontally compressed image while maintaining its original height.

### LETTER BOX(16:9)

Outputs a vertically compressed image while maintaining its original aspect ratio.

### EDGE CROP

Outputs the central portion of the original image by cropping its right and left edges.

## Notes

- When you view a movie recorded in DV with [ WIDE REC] set to [ON] on a standard 4:3 TV, images may appear horizontally compressed while maintaining its original height. In such a case, select [LETTER BOX(16:9)] or [EDGE CROP].
- If you change the setting from [SQUEEZE] to another option, or from another option to [SQUEEZE], the screen will go out momentarily, and the image and sound will be intermitted.

## ■ HDMI TC OUTPUT

You can set whether to output time code to other professional-use devices, using HDMI.

### ► OFF

Does not overlap the time code information on HDMI output signal.

### ON

Overlaps the time code information on HDMI output signal\*. The data is transmitted as digital data, not as a projected image, and the connected device identifies the time data by referencing the transmitted digital data.

\* If the frame rate is 24p, 2-3 pulldown is performed and the converted information is automatically added and transmitted.

## ■ SDI/HDMI REC CONTROL

When the camcorder is connected to an external recorder, you can set whether the external recorder automatically starts/stops recording based on the camcorder's operations.

### ► OFF

Does not record to an external recorder automatically based on the camcorder's operations.

### ON

Records to an external recorder automatically based on the camcorder's operations.

# 🎵 (AUDIO SET) menu

## Settings for the audio recording (AVCHD AUDIO FORMAT, etc.)

The default settings are marked with ▶.

See page 81 for details on selecting menu items.

Press the MENU button → select 🎵 (AUDIO SET) with the ▲/▼/◀/▶/EXEC button.

## VOLUME

You can adjust the volume.

### 💡 Tips

- You can assign this function to an ASSIGN button.

## AVCHD AUDIO FORMAT

You can set the audio format for AVCHD recording.

### ▶ LINEAR PCM (🎵LPCM)

Records in LPCM format.

### DOLBY DIGITAL (🎵DolbyD)

Records in Dolby Digital format.

### 🔊 Notes

- Audio format is fixed to LPCM with the DV recording.

## AUDIO REC LEVEL

### ■ REC LEVEL MODE

You can set the recording sensitivity.

#### ▶ NORMAL

Sensitivity generally used for professional-use devices.

#### HIGH

Sensitivity generally used for consumer-use devices.

#### MANUAL

In [MANUAL REC LEVEL], you can set the desired sensitivity level between 1 and 31.

### 🔊 Notes

- When using a shoe microphone, the setting is NORMAL.

### ■ MANUAL REC LEVEL

You can set the recording sensitivity when the recording mode is [MANUAL].

#### ▶ 1 - 31 (▶21)

## INT MIC WIND

You can diminish low tone in input sound with the internal microphone, and reduce wind noise.

### ▶ OFF

Disables wind noise reduction.

### ON

Enables wind noise reduction.

## MIC SELECT

You can select the microphone to use for recording audio.

### ▶ AUTO

The microphone used for recording audio is automatically selected based on the microphone that is connected.

The microphone is selected in the following order of priority:

External microphone connected to MIC jack (PLUG IN POWER) > Microphone connected to XLR handle unit or Multi Interface Shoe compatible microphone > Internal microphone

### 🔊 Notes

- When [AUTO] is selected and the XLR handle unit is connected to the camcorder without a microphone attached to the INPUT1 and INPUT2 jacks, the internal microphone is not selected and no audio is recorded. In this case, select [INT MIC].

### INT MIC (🎵INT)

The camcorder's internal microphone is used to record audio.



## MI SHOE MIC (🎤)

A microphone connected to the XLR handle unit or a Multi Interface Shoe compatible microphone is used to record audio.

## STEREO MINI MIC (🎤)

You can record audio using a microphone connected to the MIC jack (PLUG IN POWER).

## AUDIO OUTPUT TIMING

You can set the timing of the audio output when recording.

### ▶ LIVE

When recording, audio is output without any delay.

### LIP SYNC

When recording, audio is synchronized with video before output.

### 💡 Tips

- Select [LIP SYNC] when using the HDMI jack to record to an external device.

## ■ (DISPLAY SET) menu

### Display settings (MARKER/DISPLAY OUTPUT, etc.)

The default settings are marked with ▶. See page 81 for details on selecting menu items.

Press the MENU button → select ■ (DISPLAY SET) with the ▲/▼/◀/▶/EXEC button.

## HISTOGRAM

The histogram displays the luminance distribution that shows how many pixels of a particular brightness exist in the image.

### ▶ OFF

Does not display the histogram.

### ON

Displays a histogram. A line appears at the 100% position, and the color of the zone above the line changes.



Histogram

### ON[ZEBRA POINT]

The histogram shows the point where the zebra pattern appears. A line is displayed at the brightness level set with [ZEBRA].

### 💡 Tips

- You can assign this function to an ASSIGN button (p. 64).

Press the MENU button → select  (DISPLAY SET) with the ▲/▼/◀/▶/EXEC button.

## ZEBRA

You can display a zebra pattern as a guide for adjusting brightness.

### ■ ON/OFF

#### ▶ OFF

Does not display the zebra pattern.

#### ON ( and the brightness level)

The zebra pattern is not recorded with the image.

### ■ LEVEL

You can select the brightness level.

#### ▶ 70 to 100 or 100+

### 💡 Tips

- The zebra pattern is a stripe pattern that appears in areas of brightness equal to or exceeding the brightness level you have set.
- You can assign [ON/OFF] to an ASSIGN button (p. 64).

## PEAKING

### ■ ON/OFF

#### ▶ OFF

Does not display the peaking.

#### ON (PEAKING)

You can display an image on the LCD screen with its outlines enhanced. This function helps you to adjust the focus.

### ■ COLOR

You can select peaking color.

#### ▶ WHITE, RED, YELLOW

### ■ LEVEL

You can select a peaking sensitivity.

#### HIGH, ▶ MIDDLE, LOW

### 🔊 Notes

- The enhanced outlines will not be recorded on the recording media.

### 💡 Tips

- You can focus more easily using this function in combination with the expanded focus function (p. 35).
- You can assign [ON/OFF] to an ASSIGN button (p. 64).

## MARKER

### ■ ON/OFF

#### ▶ OFF

Does not display markers.

#### ON

Displays markers. Markers are not recorded on the recording media.

### ■ CENTER

#### ▶ ON

Displays a marker at the center of the LCD screen.

#### OFF

Does not display a center maker.



### ■ ASPECT

#### ▶ OFF

Does not display the aspect ratio.

**4:3, 13:9, 14:9, 15:9, 1.66:1, 1.85:1, 2.35:1**

Displays markers at boundaries of display area defined by the aspect ratio.



### ■ SAFETY ZONE

#### ▶ OFF

Does not display the safety zone.

**80%, 90%**

If you select either one, you can display markers at boundaries of display area that regular home TVs can display.



## GUIDEFAME

### ► OFF

Does not display the guide frame.

### ON

Displays the guide frame.

You can check the horizontal and vertical aspect of a subject.



## Notes

- Only the time code is output to an external device via external output jacks when [MARKER] is set to [ON], even if [DISPLAY OUTPUT] is set to [ALL OUTPUT].
- You cannot display markers during [FOCUS MAGNIFIER].
- You cannot output markers on an external device.

## Tips

- You can display all types of markers at the same time.
- You can obtain a balanced composition by positioning the subject at the cross points of the guideframe marker.
- You can assign [ON/OFF] to an ASSIGN button (p. 64).

## FOCUS MAG RATIO

You can set the magnification of expanded focus.

×4.0

×8.0

### ► ×4.0/×8.0

The setting changes in the order [×4.0] → [×8.0] → [OFF] with each press of the ASSIGN4 button/FOCUS MAGNIFIER button.

## CAMERA DATA DISPLAY

### OFF

Does not display the iris, gain and shutter speed settings.

### ► ON

Constantly displays the iris, gain and shutter speed settings on the LCD screen.

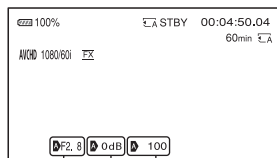

Iris value

Shutter speed value

Gain value

## Tips

- The settings appear on the LCD screen during the manual adjustment regardless of the settings of this function.
- **A** indicates that the settings are automatically adjusted values.
- **E** appears when exposure is fixed by [SPOT METER] or [SPOT METER/FOCUS].
- The displayed settings are different from the settings that will be displayed when you press the ASSIGN button to which [DATA CODE] is assigned (p. 71).
- You can assign this function to an ASSIGN button (p. 64).

## AUDIO LEVEL DISPLAY

### ► ON

Displays the audio level meters on the LCD screen.

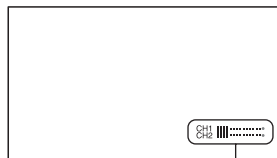

Audio level meters

Press the MENU button → select  (DISPLAY SET) with the ▲/▼/◀/▶/EXEC button.

## OFF

Does not display the audio level meters.

### Tips

- You can assign this function to an ASSIGN button (p. 64).

## ZOOM DISPLAY

### ▶ BAR

Displays a bar that indicates the zoom position.

### NUMBER

Displays a number that indicates the zoom position.

## FOCUS DISPLAY

### ▶ METER

Displays the focal length in meters.

### FEET

Displays the focal length in feet.

## SHUTTER DISPLAY

### ▶ SECOND

Displays the shutter display in seconds.

### DEGREE

Displays the shutter display in degrees.

The shutter speed equal to the period that your camcorder reads image data from the image sensor is defined as 360 degrees. The degree is calculated based on this definition and displayed.

- When [60i] is selected
  - With a frame rate of 60 selected in [REC FORMAT], when the shutter speed is 1/60, the shutter angle is 360 degrees.
  - With a frame rate of 30 selected in [REC FORMAT], when the shutter speed is 1/30, the shutter angle is 360 degrees.
  - With a frame rate of 24 selected in [REC FORMAT], when the shutter speed is 1/24, the shutter angle is 360 degrees.
- When [50i] is selected

– With a frame rate of 50 selected in [REC FORMAT], when the shutter speed is 1/50, the shutter angle is 360 degrees.

– With a frame rate of 25 selected in [REC FORMAT], when the shutter speed is 1/25, the shutter angle is 360 degrees.

See page 37 for details on [REC FORMAT] setting.

### Notes

- When you press the ASSIGN button to which [DATA CODE] is assigned, the shutter speed is displayed in seconds regardless of this setting.

### Tips

- If the shutter speed is more than 360 degrees, it is displayed as an integral multiple of 360 degrees (360° × 2, etc.).

## DATA CODE

You can select the information that is displayed during playback.

### ▶ OFF

No information is displayed.

### DATE/TIME

The date and time are displayed.

### CAMERA DATA

Camera data is displayed.

### Tips

- You can assign this function to an ASSIGN button.

## LCD BRIGHT

You can adjust the brightness of the LCD screen. Changes in the LCD brightness are not affect the brightness of recording images.

### ▶ NORMAL

### BRIGHT

## VF COLOR TEMP.

You can change the color temperature of the viewfinder.

Low color temperature makes the viewfinder appear reddish, and high color temperature makes it appear bluish.

## DISPLAY OUTPUT

You can select where to output the display information, such as time code.

### ▶ LCD PANEL

Outputs the information to the LCD screen.

### ALL OUTPUT

Outputs information to the SDI OUT, HDMI OUT, and VIDEO OUT jacks, and the LCD screen. Zebra, peaking and the frame on the face are also output.

### 🔌 Notes

- Only the time code, zebra, peaking and the frame on the face are output when [MARKER] is set to [ON] and a marker is displayed on the LCD screen.

## 00:00 (TC/UB SET) menu

Time code settings (TC PRESET/UB PRESET/TC FORMAT, etc.)

The default settings are marked with ▶. See page 81 for details on selecting menu items.

Press the MENU button → select 00:00 (TC/UB SET) with the ▲/▼/◀/▶/EXEC button.

## TC/UB DISPLAY

You can select whether to display the time code or the user bit code.

### ▶ TC

Displays the time code.

### U-BIT

Displays the user bit code.

### 💡 Tips

- You can assign this function to an ASSIGN button.

## TC PRESET

See page 60.

## UB PRESET

See page 60.

## TC FORMAT (only when [60i] is selected)

You can select the time code recording method (only when [60i] is selected). When selecting [50i], this setting is fixed to [NDF].

### ▶ DF

Records the time code in drop frame.

### NDF

Records the time code in non-drop frame.

### 🔌 Notes

- This setting is fixed to [NDF] when the frame rate in [REC FORMAT] is set to 24.

Press the MENU button → select **00:00** (TC/UB SET) with the ▲/▼/◀/▶/EXEC button.

## Tips

Drop frame

Time code is based on 30 frames per second; however, gaps in the actual time occur during extended periods of recording as the actual frame frequency of NTSC image signal is 29.97 frames per second. Drop frame corrects this gap to make time code and actual time equal. In drop frame, the first 2 frame numbers are removed every minute except in every tenth minute. Time code without this correction is called non-drop frame.

## TC RUN

You can select how the time code advances.

### ▶ REC RUN

Advances the time code only during recording.

Select this setting to record the time code sequentially from the last time code of the previous recording.

### FREE RUN

Advances the time code regardless of operation of your camcorder.

## Notes

- Even if the time code advances in the [REC RUN] mode, the time code may not be recorded sequentially in the following cases:
  - When the recording format is changed.
  - When the recording media is removed.

## TC MAKE

### ▶ PRESET

Records the newly set time code on the recording media.

### REGENERATE

Reads the last time code of the previous recording from the recording media and records the new time code consecutively from the last time code during the backspace editing.

The time code runs in [REC RUN] mode regardless of the setting of [TC RUN].

## UB TIME REC

### ▶ OFF

Does not save the actual time in the user bit code.

### ON

Saves the actual time in the user bit code.

## Notes

- The last 2 digits are fixed to 00 when it is set to [ON].

# 📶 (NETWORK SET) menu

Settings for the Wi-Fi function (CTRL W/  
SMARTPHONE, etc.)

The default settings are marked with ►.  
See page 81 for details on selecting  
menu items.

Press the MENU button → select  
📶 (NETWORK SET) with the ▲/▼/◀/  
▶/EXEC button.

## CTRL W/SMARTPHONE

See page 50.

## AIRPLANE MODE

Wi-Fi-related settings can be disabled  
(when boarding a plane, etc.).

### ► OFF

Airplane mode is turned off.

### ON (⬆)

Airplane mode is turned on.

⬆ will be displayed on the screen.

## EDIT DEVICE NAME

You can change the name of a Wi-Fi Direct  
device, etc.

## How to use the keyboard

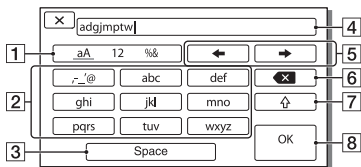

Screen items	Functions
1 Switch character type	Characters switch between alphabetical letters, numerals and symbols.
2 Keyboard	Characters are displayed in the order they are touched.

Screen items	Functions
3 Space	Enters a space.
4 Input box	Entered characters are displayed.
5 Move cursor	Moves the cursor in the input box to the left or right
6 Delete	Deletes the character preceding the cursor
7 ↕	Switches between uppercase and lowercase alphabetical letters
8 OK	Confirms an input operation

To cancel character input midway, press  
✕.

## DISP MAC ADDRESS

You can display the camcorder's MAC  
address.

## SSID/PW RESET

The connection information that you  
registered in order to use [CTRL W/  
SMARTPHONE] can be reset.

### 🔔 Notes

- If the connection information has been reset, it will be necessary to set up the smartphone again, in order to connect it to the camcorder.

## (OTHERS) menu

### Settings while recording or other basic settings (AREA SET/BEEP, etc.)

The default settings are marked with ►.  
See page 81 for details on selecting menu items.

Press the MENU button → select  (OTHERS) with the ▲/▼/◀/▶/EXEC button.

### STATUS CHECK

See page 72.

### CAMERA PROFILE

You can save up to 99 camera profile settings in a memory card for easy recall at any time.

In addition, if you should require multiple camcorders with the same settings, you can load the desired settings to all cameras via the memory card.

#### Notes

- Camera profiles with a different [60i/50i SEL] setting are not compatible.
- The file may not be shown properly if the file name is changed on the computer, or the power turned off during generation.
- Formatting the memory card also deletes saved camera profiles.

#### Tips

- Items that can be saved include setting values for menus, picture profiles, buttons, etc. You can save these setting values all together in the camera profile.

#### LOAD

Load the camera profile, and execute the settings.

- ① Select the camera profile to be loaded with the ▲/▼/◀/▶/EXEC button.
- ② Select [YES] on the confirmation screen.  
The camcorder restarts, and the loaded camera profile becomes effective.

#### Notes

- A camera profile saved on a camcorder with different model name, or edited on a computer cannot be loaded.

#### SAVE

You can save the camera profile.

- ① Select [NEW FILE] or an existing profile name with the ▲/▼/◀/▶/EXEC button.
- ② Select [YES] on the confirmation screen.  
The camera profile is saved.

#### Tips

- When you select [NEW FILE], the profile is named [01] (when saving for the first time).
- If you select an existing camera profile, the current setting values are overwritten.
- You cannot use a computer to edit saved settings.

#### DELETE

You can delete the saved camera profile.

- ① Select the camera profile to be deleted with the ▲/▼/◀/▶/EXEC button.
- ② Select [YES] on the confirmation screen.

### ASSIGN BUTTON

See page 64.

### CLOCK SET

See page 24.

### AREA SET

You can adjust a time difference without stopping the clock. When you use your camcorder abroad, you can adjust the clock to the local time.



## SUMMERTIME

You can change this setting without stopping the clock. Set to [ON] to move the time forward 1 hour.

### ► OFF

Does not set the summertime.

### ON

Sets the summertime.

## LANGUAGE

You can select the language to be used on the LCD screen.

## DATE REC

### ► OFF

Does not superimpose the date and time on images.

### ON

Superimposes the date and time on images.

### Tips

- You can set this item only when the interlace scanning system is selected.
- When zebra or peaking is activated, the date and time characters are affected by the signal, but properly recorded on images.

## BEEP

### ► OFF

Cancels the melody.

### ON

Activates a melody when you start/stop recording, or when you are warned with warning indicators, etc.

## REC LAMP

### ► ON

Turns on the recording lamp.

### OFF

Turns off the recording lamp.

### Tips

- You can assign this function to an ASSIGN button (p. 64).

## REMOTE CONTROL

### ► ON

Enables the supplied Wireless Remote Commander (p. 12).

### OFF

Disables the supplied Wireless Remote Commander to prevent misoperation by the remote control of another device.

## 60i/50i SEL

You can select the frame rate depending on the regional video signal format used by your camcorder.  
The camcorder automatically restarts if you change the setting.

### 60i

Select for NTSC video format.

### 50i

Select for PAL video format.

The default setting is 60i for NTSC and 50i for PAL.

Refer to the label on the bottom of the set.

### Notes

- Recording media formatted or recorded at 60i (50i) cannot record or play back at 50i (60i), and vice versa. Use another memory card or perform [MEDIA FORMAT] if the [A movie with a different video signal format from this device has been recorded. Movie recording disabled.] message is displayed after you change the 60i/50i setting.
- Protected movies are also deleted when [MEDIA FORMAT] is performed.

## MEDIA FORMAT

See page 78.

Press the MENU button → select  (OTHERS) with the ▲/▼/◀/▶/EXEC button.

## REPAIR IMAGE DB FILE

See page 80.

## USB CONNECT

Select this item when [USB CONNECT] does not appear on the LCD screen by connecting the camcorder to another device with the USB cable.

## USB LUN SET

You can improve compatibility with external devices by limiting the functions of the USB connection.

### ► MULTI

Set to [MULTI] in normal conditions.

### SINGLE

Set to [SINGLE] if you are unable to connect using the [MULTI] setting.

## OPERATION TIME

Displays the total hours of operation in 10-hour increments.

## VERSION DISPLAY

Displays the current version of your camcorder. Be sure to check for firmware updates.

### Notes

- To perform an update, use the AC Adaptor.

## CALIBRATION

See page 123.

## INITIALIZE

You can reset all settings, including the clock setting, to their default values.

### Notes

- The picture profile settings are not reset.

## Creating a standard definition image quality (SD) disc with a recorder, etc.

You can copy images on your camcorder onto a disc or video cassette, by connecting your camcorder to a disc recorder with the A/V connecting cable (sold separately). Refer also to the instruction manuals supplied with the devices to be connected.

### ⚙ Notes

- High definition image quality (HD) movies will be copied with standard definition image quality (SD).

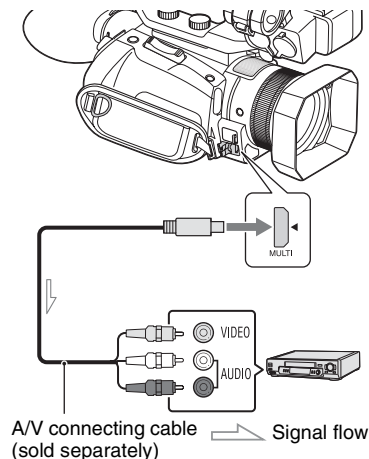

**1** Connect your camcorder to the wall outlet (wall socket) using the AC Adaptor AC-L200D (supplied) (p. 21).

**2** Insert the recording media in the recording device.

If your recording device has an input selector, set it to the input mode.

**3** Connect your camcorder to the recording device (a disc recorder, etc.) with the A/V connecting cable (sold separately).

Connect your camcorder to the input jacks of the recording device.

**4** Start playback on your camcorder, and record it on the recording device.

For details, refer to the instruction manuals supplied with the device to be connected.

**5** When copy is finished, stop the recording device, and then your camcorder.

### ⚙ Notes

- Since copying is performed via analog data transfer, the image quality may deteriorate.
- You cannot copy images to recorders connected with an HDMI cable.
- When you do not want to display the counter, etc. on the screen of the recording device, press the MENU button, and select (DISPLAY SET) → [DISPLAY OUTPUT] → [LCD PANEL].
- To copy date/time information and camera data, press the ASSIGN button to which [DATA CODE] is assigned and make the desired setting. In addition, press the MENU button, select (DISPLAY SET) → [DISPLAY OUTPUT] → [ALL OUTPUT].
- When the screen size of display devices (TV, etc.) is 4:3, set [DOWN CONVERT TYPE] (p. 91).
- When you connect a monaural device, connect the yellow plug of the A/V connecting cable (sold separately) to the video input jack, and the white (left channel) or the red (right channel) plug to the audio input jack on the device.

# Troubleshooting

If you run into any problems using your camcorder, follow the flow chart below.

① Check your camcorder, referring to the items on pages 104 to 110.

② Disconnect the power source, reconnect the power source after about 1 minute and turn on your camcorder.

③ Select  (OTHERS) → INITIALIZE.  
This operation will reset the date, time and area settings.

④ Consult your Sony dealer or local authorized Sony service facility.

- Power sources/LCD screen/Wireless Remote Commander...p. 104
- Memory card...p. 105
- Recording...p. 106
- Playback...p. 108
- Connecting to TV...p. 109
- Copying/Editing/Connecting to other devices...p. 109
- Connecting to a computer...p. 110

## Power sources/LCD screen/Wireless Remote Commander

### The power does not turn on or abruptly turns off.

- Attach a charged battery pack to the camcorder (p. 21).
- Use the AC Adaptor to connect the camcorder to a wall outlet (wall socket) (p. 21).

### The camcorder does not operate even when the power is set to on.

- Disconnect the power source (battery or AC Adaptor), then reconnect it after about 1 minute.
- Select  (OTHERS) → INITIALIZE.

### The camcorder gets warm.

- The camcorder may get warmer while you use it. This is not a malfunction.

### The remaining battery indicator does not indicate the correct figure.

- Ambient temperature is too high or too low, or the battery pack has not been charged enough. This is not a malfunction.
- Fully charge the battery again. If the problem persists, the battery may be worn-out. Replace it with a new one (p. 21, 120).
- The indicated figure may not be correct in certain circumstances. For example, when you open or close the LCD screen, it takes about 1 minute to display the correct remaining battery.

---

**The battery pack discharges too quickly.**

- Ambient temperature is too high or low, or the battery pack has not been charged enough. This is not a malfunction.
- Fully charge the battery again. If the problem persists, the battery may be worn-out. Replace it with a new one (p. 21, 120).

---

**The image on the viewfinder is not clear.**

- Move the viewfinder lens adjustment lever until the image appears clearly (p. 26).

---

**The supplied Wireless Remote Commander does not function.**

- Set [REMOTE CONTROL] to [ON] (p. 101).
- Remove any obstructions between the Wireless Remote Commander and the remote sensor of the camcorder.
- Keep strong light sources, such as sunlight or overhead lighting, away from the remote sensor, otherwise the Wireless Remote Commander may not function properly.
- Insert a fresh battery in the compartment with its +/- terminals matching those of the compartment (p. 12).

---

**Another video device malfunctions when you use the supplied Wireless Remote Commander.**

- Select a commander mode other than DVD2 for your video device.
- Cover the sensor of your video device with black paper.

---

**The touch panel is open, but the LCD screen is not displayed.**

- The LCD screen is not displayed if the eye sensor detects something nearby and the camcorder switches to viewfinder view.

## Memory card

---

**The camcorder does not operate with the memory card inserted.**

- The memory card was formatted on a computer. Format it on this camcorder (p. 78).

---

**The data file name is incorrect, or flashing.**

- The file is damaged.
- Use a file format supported by your camcorder (p. 117).

---

**The recording media indicator is flashing.**

- Something wrong happened to recording media. Stop recording of all recording media, and repair the database file.

### **Images on the recording media cannot be deleted.**

- You can select no more than 100 images to be deleted on the edit screen.
- The images are protected. Unprotect the images (p. 76).

## Recording

### **The recording does not start when you press the START/STOP button.**

- The playback screen is displayed. Finish playback operation (p. 68).
- There is no empty space on the recording media. Replace the recording media with a new one, delete unnecessary images (p. 77) or format the recording media (p. 78).
- Total number of movie scenes exceeds the recordable capacity of your camcorder (p. 115). Delete unnecessary images (p. 77).
- The temperature of your camcorder is extremely high. Turn off your camcorder and leave it for a while in a cool place.
- The temperature of your camcorder is extremely low. Turn off your camcorder and leave it for a while in a warm place.
- Something wrong happened to one of recording media. Stop recording of all recording media, and repair the database file.

---

### **The handle zoom does not work.**

- Set the handle zoom switch to VAR or FIX (p. 33).

---

### **The access lamp remains lit even after recording was stopped.**

- Your camcorder is recording the scene you have just shot on the memory card.

---

### **The imaging field looks different.**

- The imaging field may look different depending on the condition of your camcorder. This is not a malfunction.

---

### **The actual recording time for movies is less than the estimated recording time of the recording media.**

- Depending on the recording conditions, the time available for recording may be shorter, for example when recording a fast moving object, etc. (p. 114).

---

### **The camcorder does not keep the setting changes.**

- Some menu items return to the default setting when the power is turned off.
- The [FOCUS MAGNIFIER] setting is not stored.
- The battery pack or AC Adaptor was disconnected while the power was turned on. Before disconnecting the battery pack or AC Adaptor, turn off the power and make sure that the access lamp is turned off.

---

**There is a time difference between the point when the START/STOP button is pressed and the point that the recording movie is started or stopped actually.**

- On your camcorder, there may be a slight time difference between the point where you press the START/STOP button and the actual point that recording movie starts/stops. This is not a malfunction.
- 

**The aspect ratio (16:9 (wide)/4:3) cannot be changed.**

- When recording at a setting other than DV, the aspect ratio of the movie cannot be changed.
- 

**Automatic focus does not function.**

- Set the focus to AUTO to enable the automatic focus function (p. 34).
  - Adjust the focus manually if the automatic focus does not work properly (p. 34).
- 

**Menu items are grayed out or do not work.**

- You cannot select grayed out display items in the current recording/playback situation.
- There are some functions you cannot activate simultaneously. The following list shows examples of unworkable combinations of functions and menu items.

Cannot use	Situation
[ON/OFF] of [AE SHIFT]	All of iris, gain and shutter speed are set manually.
[ZEBRA], [PEAKING]	[COLOR BAR] is set to [ON].
[ON/OFF] of [MARKER]	[FOCUS MAGNIFIER] is set to [ON].
[TC PRESET]	[TC MAKE] is set to [REGENERATE].
[COLOR BAR]	Movies are being recorded. [FOCUS MAGNIFIER] is set to [ON].

---

**Iris, gain, shutter speed, or white balance cannot be adjusted manually.**

- Set the AUTO/MANUAL switch to MANUAL.
- 

**Tiny spots in white, red, blue, or green appear on the LCD screen.**

- This phenomenon appears when using a slow shutter speed (p. 40). This is not a malfunction.
- 

**The subjects passing by the frame very fast appear crooked.**

- This is called the focal plane phenomenon. This is not a malfunction. Because of the way that the image device (CMOS sensor) reads out image signals, the subjects passing by the frame rapidly might appear crooked depending on the recording conditions.
- 

**Horizontal stripes appear on the image.**

- This occurs when recording pictures under a fluorescent lamp, sodium lamp, or mercury lamp. This is not a malfunction. This can be improved by changing the shutter speed (p. 40).

### **Black bands appear when you record a TV screen or computer screen.**

- This can be improved by adjusting the shutter speed (p. 40).
- 

### **Fine patterns flicker, diagonal lines look jagged.**

- Adjust [DETAIL] to the negative side (p. 59).
- 

### **The time code is not recorded in sequence.**

- The time code may not be recorded sequentially if you change the settings of [REC FORMAT].
- 

### **Image color is not correct.**

- Cancel NIGHTSHOT (p. 48).
- 

### **The image is not visible because the screen is too bright.**

- Cancel NIGHTSHOT (p. 48).
- 

## Playback

Refer also to the “Memory card” section (p. 105).

---

### **The desired images cannot be found.**

#### **Images cannot be played back.**

- Select the recording media and image quality of the image you want to play back on the THUMBNAIL screen (p. 66).
  - Image data cannot be played back if you have modified file names or folders, or have edited the data on a computer (When viewing still images, the file name flashes). This is not a malfunction.
  - Images recorded on other devices may not be played back, or displayed in incorrect size. This is not a malfunction.
  - Display the THUMBNAIL screen, touch twice on the thumbnail of the image you want to play back, or select the thumbnail with ▲/▼/◀/▶ buttons and press the EXEC button (p. 67).
- 

### **The data file name is displayed incorrectly, or flashing.**

- The file is damaged.
  - The file format is not supported on your camcorder (p. 117).
  - Only the file name is displayed, if the folder structure does not conform to the universal standard.
- 

### **No sound or only a low sound is heard.**

- Turn up the volume (p. 68).



---

**“---” is displayed on the LCD screen.**

- Bars will be displayed for the camera data of the movies recorded with [COLOR BAR] set to [ON].

---

**Multi ch appears on the LCD screen.**

- This appears when you play back movies recorded with 5.1ch surround sound. 5.1ch surround sound is down-mixed to 2ch stereo and played back on your camcorder.

## Connecting to TV

---

**Neither image nor sound is played back on the TV connected with the HDMI cable.**

- Images are not output from the HDMI OUT jack, if copyright protection signals are recorded in the images.
- Signals are not output from the HDMI OUT jack when the USB jack is connected.
- Images are not output from the HDMI OUT jack, if the [HDMI] is not selected from the [OUTPUT SELECT] (p. 90).

---

**Neither image nor sound is played back on the TV, projector, or AV amplifier connected with the HDMI cable.**

- If you cannot view images or hear sound on the TV, projector, or AV amplifier connected with the HDMI cable, try disconnecting and connecting the HDMI cable, or turn on your camcorder again.

---

**The image appears distorted on the 4:3 TV.**

- This happens when viewing a movie recorded in the 16:9 (wide) mode on a 4:3 TV. Select  (REC/OUT SET) → [VIDEO OUT] → [DOWN CONVERT TYPE] → the appropriate down conversion type (p. 91).

---

**Black zone appears at top and bottom of a 4:3 TV screen.**

- This happens when viewing a movie recorded in the 16:9 (wide) mode on a 4:3 TV. This is not a malfunction.

## Copying/Editing/Connecting to other devices

---

**Time code and other information appear on the display of the connected device.**

- Set [DISPLAY OUTPUT] to [LCD PANEL] when you connect a device with the A/V connecting cable (sold separately) (p. 97).

---

**Copy cannot be done correctly using the A/V connecting cable (sold separately).**

- The A/V connecting cable (sold separately) is not connected properly. Make sure that the A/V connecting cable (sold separately) is connected to the input jack of the device.

### **Sound cannot be added to the recording media after recording.**

- You cannot add sound to the recording media after recording on your camcorder.
- 

### **Copy cannot be done correctly using the HDMI cable.**

- You cannot copy movies using the HDMI cable.
- 

## **Connecting to a computer**

### **The computer does not recognize the camcorder.**

- Disconnect the cable from the computer, then connect it again securely.
  - Disconnect the cable from your computer and camcorder. Reboot your computer, and connect your computer and camcorder following the steps in the correct order.
- 

### **Movies cannot be viewed or copied to the computer.**

- Disconnect the cable from the computer, then connect it again.
- You need to install the “Content Browser” to copy movies from your camcorder to your computer.

# Warning indicators and messages

## Self-diagnosis display/Warning indicators

When an error occurs, a warning indicator appears on the LCD screen or in the viewfinder.

You can fix some problems associated with the symptoms yourself. If the problem persists even after you have tried a couple of times, contact your Sony dealer or local authorized Sony service facility.

---

### C:04:□□

- The battery pack is not an “InfoLITHIUM” battery pack. Use an “InfoLITHIUM” battery pack (p. 120).

---

### C:06:□□

- The battery pack is too hot. Replace the battery pack, or remove the battery pack and put it in a cool place.

---

### C:13:□□

- Remove the recording media. After installing them again, operate your camcorder.

---

### C:32:□□

- Remove the power source. Reconnect it and operate your camcorder again.

---

### E:□□:□□

- Try the steps ② to ④ on page 104.

---

### ⚠ (Battery level warning)

- The battery pack is nearly used up.
- Depending on the operation, environment, or battery conditions, ⚠ may flash, even if around 10% is displayed as the battery remaining figure.

---

### ⚠ (Warning indicator pertaining to battery pack temperature)

- The battery pack is too hot. Replace the battery pack, or remove the battery pack and put it in a cool place.

---

### ⚠ (Warning indicator pertaining to memory cards)

#### Slow flashing

- Free spaces for recording images are running out. For the type of memory cards you can use with your camcorder, see page 27.
- No memory card is inserted (p. 27).
- There is not enough free space for recording images. Delete unnecessary images (p. 77), or format the memory card (p. 78) after you save the images to your computer or another device.
- The image database file may be damaged (p. 80).

---

### ⚠ (Warning indicator pertaining to memory card formatting)\*

- The memory card is damaged.
- The memory card is not formatted correctly (p. 78).

---

### ⚠ (Warning indicator pertaining to incompatible memory cards)\*

- Incompatible memory card is inserted (p. 27).

---

### (Warning indicator pertaining to the write-protect of the memory card)\*

- The write-protect switch is set to lock position on the memory card.
- Access to the memory card was restricted on another device.

---

\* When [BEEP] is set to [ON] (p. 101), you hear a melody when the warning indicators appear on the LCD screen.

### Description of warning messages

If messages appear on the LCD screen or in the viewfinder, follow the instructions.

#### Recording media

---

### Inconsistencies found in image database file. Do you want to repair the image database file? Inconsistencies found in image database file. Cannot record or play HD movies. Do you want to repair the image database file?

- You cannot record or play back movies because no movie management information exists. If you touch [OK], new management information is created and you can record or play back movies.

---

### Inconsistencies found in the image database file. Back up and recover. Recover, then import using the included PC software.

- Inconsistencies occur in the image database file because movie management information is damaged. If you touch [OK], new management information is created by backing up a movie. The backed up movies cannot be recognized. If you connect to a computer that has been installed with the software “Content Browser,” you can copy the backed up movies.

---

### Buffer overflow. Writing to the media was not completed in time.

- You have performed recording and erasing operations repeatedly, or a memory card that has been formatted by other device is used. Copy and take data backup to other device (such as a computer), and then [Empty] the memory card on the camcorder (p. 79).
- The size of the inserted memory card is not sufficient for copying the movie(s). Use the recommended memory card (p. 27).

---

### Recovering data.

- Your camcorder tries to recover data automatically if the data writing was not performed properly.

---

### Cannot recover data.

- Writing data onto the media of the camcorder has failed. Attempts were made to recover the data, but they were unsuccessful.

---

### Reinsert the memory card.

- Reinsert the memory card a few times. If even then the indicator flashes, the memory card could be damaged. Try with another memory card.

---

### Cannot recognize this memory card. Format and use again.

- Format the memory card (p. 78). Note that if you format the memory card, all the recorded movies and photos are deleted.

---

**Still picture folder is full.  
Cannot record still pictures.**

- You cannot create folders exceeding 999MSDCF. You cannot create or delete created folders using your camcorder.
- Format the memory card (p. 78), or delete folders using your computer.

---

**This memory card may not be able to record or play movies.**

- Use a memory card recommended for your camcorder (p. 27).

---

**This memory card may not be able to record or play images correctly.**

- Use a memory card recommended for your camcorder (p. 27).
- Contact your Sony dealer.

---

**Do not eject the memory card during writing. Data may be damaged.**

- Reinsert the memory card, and follow the instructions on the LCD screen.

---

**Other**

---

**Maximum number of images already selected.**

- You can select only 100 images at one time for:
  - Deleting movies/photos
  - Protecting movies/photos, or releasing the protection

---

**Protected file. Cannot delete.**

- You tried to delete protected data. Release the protection of the data.
-

# Recording time of movies

## Estimated time of recording and playback with each battery pack

Approximate time available when you use a fully charged battery pack.

### Recording time

(unit: minute)

Battery pack	Continuous recording time	Typical recording time
NP-FV70	120	60

### Notes

- Recording format
- XAVC HD 1080/60i 50Mbps
- Using an XLR microphone with [LCD BRIGHT] set to [NORMAL]
- Using a memory card
- Typical recording time shows the time when you repeat recording start/stop, turning on/off, and so on.
- Times measured when using the camcorder at 25 °C (77 °F).
- Both recording and playback time will be shorter when you use your camcorder in low temperatures. It is recommended that you use the camcorder from 10 °C to 30 °C (50 °F to 86 °F).
- The recording and playback time will be shorter depending on the conditions under which you use your camcorder.

### Playing time

(unit: minute)

Battery pack	
NP-FV70	200

## Estimated recording time of movies

### XAVC HD

(unit: minute)

	1080		720	
	50Mbps	35Mbps	25Mbps	50Mbps
64GB	120 (120)	170 (170)	220 (220)	120 (120)

### AVCHD

#### ■ When [AVCHD AUDIO FORMAT] is set to [LINEAR PCM]

(unit: minute)

	PS	FX	FH	HQ
16 GB	70 (70)	80 (80)	110 (110)	185 (145)
32 GB	145 (145)	170 (170)	225 (225)	375 (290)
64 GB	290 (290)	340 (340)	450 (450)	750 (590)

#### ■ When [AVCHD AUDIO FORMAT] is set to [DOLBY DIGITAL]

(unit: minute)

	PS	FX	FH	HQ
16 GB	75 (75)	90 (90)	120 (120)	215 (165)
32 GB	150 (150)	180 (180)	245 (245)	440 (330)
64 GB	305 (305)	360 (360)	495 (495)	880 (665)

## DV

(unit: minute)

	HQ
16 GB	70 (70)
32 GB	140 (140)
64 GB	280 (280)

- When using Sony memory card.

### Notes

- The recordable time may vary depending on the recording conditions, subjects, and [REC SET] (p. 90).
- The number in ( ) is the minimum recordable time.

### Tips

- The maximum number of movie scenes that can be recorded is 600 in XAVC HD, 3,999 in AVCHD, and 9,999 in DV.
- The maximum continuous recording time for movies in XAVC HD is approximately 6 hours. When recording in AVCHD and DV, the maximum continuous recording time is approximately 13 hours.
- Your camcorder uses the VBR (Variable Bit Rate) format to automatically adjust image quality to suit the recording scene. This technology causes fluctuations in the recording time of the media. Movies containing quickly moving and complex images are recorded at a higher bit-rate, and this reduces the overall recording time.
- Bit-rate (movie + audio, etc.), number of pixels, and aspect ratio of each recording mode of movies are as follows.
  - XAVC HD

60i	50i
1080/60p 50Mbps	1080/50p 50Mbps
1080/60p 35Mbps	1080/50p 35Mbps
1080/60i 50Mbps	1080/50i 50Mbps
1080/60i 35Mbps	1080/50i 35Mbps
1080/60i 25Mbps	1080/50i 25Mbps
1080/30p 50Mbps	1080/25p 50Mbps
1080/30p 35Mbps	1080/25p 35Mbps
1080/24p 50Mbps	-

60i	50i
1080/24p 35Mbps	-
720/60p 50Mbps	720/50p 50Mbps

- AVCHD
  - PS: max. 28 Mbps 1,920 × 1,080/16:9
  - FX: max. 24 Mbps 1,920 × 1,080/16:9, 1,280 × 720/16:9
  - FH: approx. 17 Mbps (ave.) 1,920 × 1,080/16:9, 1,280 × 720/16:9
  - HQ: approx. 9 Mbps (ave.) 1,440 × 1,080/16:9, 1,280 × 720/16:9
  - LP: approx. 5 Mbps (ave.) 1,440 × 1,080/16:9
- DV
  - approx. 25 Mbps (ave.) 720 × 480 (when selecting [60i]), 720 × 576 (when selecting [50i])/16:9, 4:3

# Using your camcorder abroad

## Power supply

You can use your camcorder in any country/region using the AC Adaptor supplied with your camcorder within the AC 100 V to 240 V, 50 Hz/60 Hz range.

## Viewing on TV

Before recording a movie with your camcorder for viewing on a TV, set [60i/50i SEL] to the appropriate TV system for the country/region in which you intended to view the movie. The following shows which countries and regions require [60i] or [50i] setting.

Countries/regions that require [60i] on [60i/50i SEL]

Bahama Islands, Bolivia, Canada, Central America, Chile, Colombia, Ecuador, Guyana, Jamaica, Japan, Korea, Mexico, Peru, Surinam, Taiwan, the Philippines, the U.S.A., Venezuela, etc.

Countries/regions that require [50i] on [60i/50i SEL]

Argentina, Australia, Austria, Belgium, Brazil, Bulgaria, China, Czech Republic, Denmark, Finland, France, Germany, Guiana, Holland, Hong Kong, Hungary, Iran, Iraq, Italy, Kuwait, Malaysia, Monaco, New Zealand, Norway, Paraguay, Poland, Portugal, Russia, Singapore, Slovak Republic, Spain, Sweden, Switzerland, Thailand, Ukraine, United Kingdom, Uruguay, etc.

## Simple setting of the clock by time difference

When you are abroad, you can easily adjust the clock to the local time by setting the time difference. Select [AREA SET], then set the time difference (p. 100).



# File/folder structure on the recording media

The file/folder structure is shown below. You do not usually need to acknowledge the file/folder structure, when recording/playing back movies and still images on the camcorder.

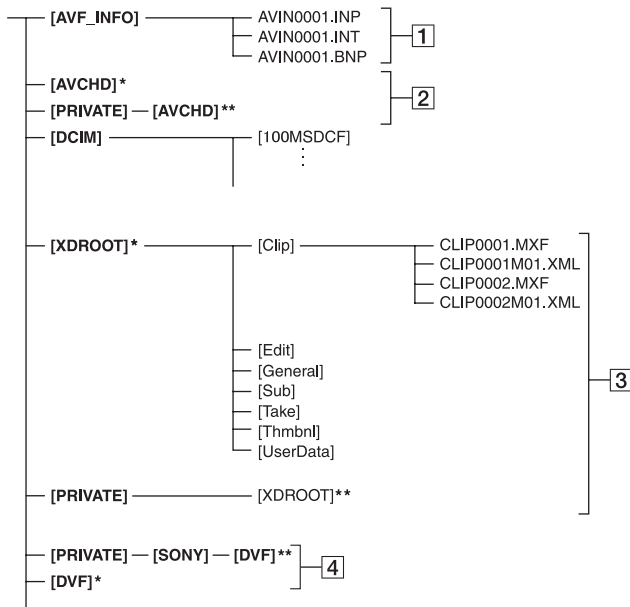

\* “Memory Stick PRO Duo” media

\*\*SD memory card, SDHC memory card, SDXC memory card

## 1 Image management files

When you delete the files, you cannot record/play back the images correctly. The files are defaulted as hidden files and not usually displayed.

## 2 AVCHD movie management information folder

This folder contains recording data of AVCHD movies. Do not try to open this folder or access the contents of this folder from a computer. Doing so might damage image files, or prevent image files from being played back.

## 3 XAVC HD movie management information folder

This folder contains recording data of XAVC HD movie files. The file numbers go up automatically.

## 4 DV movie management information folder

This folder contains recording data of DV movie. Do not try to open this folder or access the contents of this folder from a computer. Doing so might damage image files, or prevent image files from being played back.

- Do not modify the files or folders on the camcorder from the computer. The image files may be destroyed or may not be played back. Operation is not guaranteed, if you perform this operation.

## File/folder structure on the recording media (Continued)

- When you delete image files, follow the steps on page 77. Do not delete the image files on the camcorder directly from the computer.
- Do not format the recording media in the camcorder using a computer. The camcorder may not operate correctly.
- Do not copy the files on the recording media from a computer. Operation is not guaranteed.
- Use the application software “Content Browser” to import data from the recording media to a computer.

# Maintenance and precautions

## About the XAVC HD format

### Recording and playback on the camcorder

Based on the XAVC HD format, your camcorder records with HD (high definition) high image quality.

XAVC HD uses a Long-GOP video compression format for recording.

Video signal\*: MPEG-4AVC/H.264

When [60i] is selected

1920×1080/60p, 1920×1080/60i,

1920×1080/30p, 1920×1080/24p,

1280×720/60p

When [50i] is selected

1920×1080/50p, 1920×1080/50i,

1920×1080/25p, 1280×720/50p

Audio signal: LPCM 2 ch

Recording media: Memory card

\* The camcorder is not able to play back data that is recorded in XAVC HD format using settings other than those described above.

## About the AVCHD format

### Recording and playback on your camcorder

Based on the AVCHD format, your camcorder records with the HD (high definition) image quality.

Video signal\*: MPEG-4AVC/H.264

When [60i] is selected

1920×1080/60p, 1920×1080/60i,

1920×1080/30p, 1920×1080/24p,

1280×720/60p

When [50i] is selected

1920×1080/50p, 1920×1080/50i,

1920×1080/25p, 1280×720/50p

Audio signal: Dolby Digital 2ch, LPCM 2 ch

Recording media: memory card (sold separately)

\* Data recorded in AVCHD format other than the above mentioned cannot be played back on your camcorder.

- Because the AVCHD format uses a data compression system, images may be distorted in scenes where the image, angle, or brightness changes drastically. This is not a malfunction.

## About the memory card

- A memory card formatted by a computer (Windows OS/Mac OS) does not have guaranteed compatibility with your camcorder.
- Data read/write speed may vary depending on the combination of the memory card and memory card compliant product you use.
- Damaged or lost image data will not be compensated for, and may occur in the following cases:
  - If you eject the memory card, turn the power off on your camcorder, or remove the battery pack for replacement while your camcorder is reading or writing image files on the memory card (while the access lamp is lit or flashing).
  - If you use the memory card near magnets or magnetic fields.
- It is recommended to make a back-up of important data on the hard disk of a computer.
- Do not attach a label or the like on memory card.
- Do not touch, or allow metallic objects to come into contact with the terminals.
- Do not bend, drop or apply strong force to the memory card.
- Do not disassemble or modify the memory card.
- Do not let the memory card get wet.
- Be careful to keep memory card out of the reach of small children. There is danger that a child might swallow it.
- Do not insert anything other than the compliant size of memory card into the memory card slot. Doing so may cause a malfunction.
- Do not use or keep the memory card in the following locations:
  - Places subject to extremely high temperature, such as a car parked outside in the summer
  - Places under direct sunlight
  - Places with extremely high humidity or subject to corrosive gases

### On image data compatibility

- Image data files recorded on a memory card by your camcorder conform to the “Design rule for Camera File system” universal standard established by the JEITA (Japan Electronics and Information Technology Industries Association).
- If you cannot use the memory card that has been used with another device, format it with your camcorder (p. 78). Note that formatting erases all information on the memory card.
- You may not be able to play back images with your camcorder:
  - When playing back image data modified on your computer.
  - When playing back image data recorded with other devices.

### About the “Memory Stick” media

Types of “Memory Stick” media	Recording /Playback
“Memory Stick Duo” media (with MagicGate)	–
“Memory Stick XC-HG Duo” media	✓
“Memory Stick PRO Duo” media (Mark2)	✓
“Memory Stick PRO-HG Duo” media	✓

- This product supports parallel data transfer. However, the transfer speed may differ, depending on the type of media you use.
- This product cannot record or play data that uses “MagicGate” technology. “MagicGate” is a copyright protection technology that records and transfers the contents in an encrypted format.

### About the “InfoLITHIUM” battery pack

Your camcorder operates only with an “InfoLITHIUM” V series battery pack of a large capacity, such as NP-FV70. “InfoLITHIUM” V series battery packs have the  mark.

### What is an “InfoLITHIUM” battery pack?

An “InfoLITHIUM” battery pack is a lithium-ion battery pack that has functions for communicating information related to operating conditions between your camcorder and a supplied AC Adaptor. The “InfoLITHIUM” battery pack displays the remaining battery time in % according to the operating situations of your camcorder.

### To charge the battery pack

- Be sure to charge the battery pack before you start using your camcorder.
- We recommend charging the battery pack in an ambient temperature of from 10 °C to 30 °C (50 °F to 86 °F) until the charge lamp of the camcorder turns off. If you charge the battery pack outside of this temperature range, you may not be able to charge it efficiently.





### To use the battery pack effectively

- Battery pack performance decreases when the ambient temperature is 10 °C (50 °F) or below, and the length of time you can use the battery pack becomes shorter. In that case, do one of the following to use the battery pack for a longer time.
  - Put the battery pack in a pocket to warm it up, and install it in your camcorder right before you start taking shots.
- Make sure to turn off the camcorder when you are not recording or playing back. The battery pack is also consumed when your camcorder is in recording standby or playback pause.
- Have spare battery packs ready for 2 or 3 times the expected recording time, and make trial recordings before making the actual recording.

- Do not expose the battery pack to water. The battery pack is not water resistant.

## About the remaining battery indicator

- Check the level with the following indicators and % displayed on the LCD screen.

Battery remaining indicator	%
	81% to 100%
	51% to 80%
	21% to 50%
	1% to 20%
	-

- The displayed level may not be correct under certain circumstances.
- When the power goes off even though the remaining battery percent indicator indicates that the battery pack has enough power to operate, charge the battery pack fully again. Remaining battery percent will be indicated correctly. Note, however, that the battery indication will not be restored if it is used in high temperatures for a long time, or if left in a fully charged state, or when the battery pack is frequently used. Use the remaining battery percent indication as a rough guide only.

## About storage of the battery pack

- If the battery pack is not used for a long time, fully charge the battery pack and use it up on your camcorder once a year to maintain proper function. To store the battery pack, remove it from your camcorder and put it in a dry, cool place.
- To discharge the battery pack on your camcorder completely, leave your camcorder in recording standby until the power goes off.

## About battery life

- Battery capacity decreases over time and through repeated use. If decreased usage time between charges becomes significant, it is probably time to replace it with a new one.
- Each battery's life is governed by storage, operating and environmental conditions.

## About charging the battery pack

- Use the AC Adaptor (supplied) to charge the designated batteries only. If you charge other types of batteries, those batteries may leak, heat up, burst, or give an electric shock, resulting in burns or injury.
- Remove the charged battery from the AC Adaptor.
- The CHARGE lamp of the supplied AC Adaptor flashes in 2 patterns as follows:
  - Fast-flashing...Turns on and off rapidly at about 0.15-second intervals.
  - Slow-flashing...Turns on and off alternately for about 1.5 seconds, and turns off completely for about 1.5 seconds. The lamp repeats this sequence.
- If the CHARGE lamp is fast-flashing, remove the battery that is being charged, and then re-attach the same battery again firmly. If the CHARGE lamp continues fast-flashing, the cause could be that the battery is damaged, or the battery is not a designated type. Check the battery to confirm whether it is a designated type or not. If it is a designated type, remove the battery first, and then attach a brand-new battery or another known-to-be-good battery to see if the AC Adaptor is working correctly. If the AC Adaptor is working correctly, the cause could be that the battery is damaged.
- If the CHARGE lamp is slow-flashing, the AC Adaptor is in standby mode and charging is suspended. When the ambient temperature is out of the appropriate temperature range for charging, the AC Adaptor suspends charging automatically and enters standby mode. When the ambient temperature returns to an appropriate temperature, the AC Adaptor restarts charging and the CHARGE lamp lights up. We recommend charging the battery pack in an ambient temperature of from 10 °C to 30 °C (50 °F to 86 °F).

### About handling of your camcorder

#### On use and care

- Do not use or store the camcorder and accessories in the following locations.
  - Anywhere extremely hot or cold. Never leave them exposed to temperatures above 60 °C (140 °F), such as under direct sunlight, near heaters or in a car parked in the sun. They may malfunction or become deformed.
  - Near strong magnetic fields or mechanical vibration. The camcorder may malfunction.
  - Near strong radio waves or radiation. The camcorder may not be able to record properly.
  - Near AM receivers and video equipment. Noise may occur.
  - On a sandy beach or anywhere dusty. If sand or dust gets in your camcorder, the camcorder may malfunction. Sometimes this malfunction cannot be repaired.
  - Near windows or outdoors, where the LCD screen, the viewfinder, or the lens may be exposed to direct sunlight. This damages the inside of the viewfinder or the LCD screen.
  - Anywhere very humid.
- Operate your camcorder on DC 6.8 V/7.2 V (battery pack) or DC 8.4 V (AC Adaptor).
- For DC or AC operation, use the accessories recommended in these operating instructions.
- Do not let your camcorder get wet, for example, from rain or sea water. If your camcorder gets wet, it may malfunction. Sometimes this malfunction cannot be repaired.
- If any solid object or liquid gets inside the casing, unplug your camcorder and have it checked by a Sony dealer before operating it any further.
- Avoid rough handling, disassembling, modifying, physical shock, or impact such as hammering, dropping or stepping on the product. Be particularly careful of the lens.
- Do not use a deformed or damaged battery pack.
- Keep the POWER switch set to OFF when you are not using your camcorder.
- Do not wrap your camcorder with a towel, for example, and operate it. Doing so might cause heat to build up inside.
- When disconnecting the power cord (mains lead), pull it by the plug and not the lead.

- Do not damage the power cord (mains lead) such as by placing anything heavy on it.
- Keep metal contacts clean.
- Keep the Wireless Remote Commander and button-type battery out of children's reach. If the battery is accidentally swallowed, consult a doctor immediately.
- If the battery electrolytic liquid has leaked,
  - consult your local authorized Sony service facility.
  - wash off any liquid that may have contacted your skin.
  - if any liquid gets in your eyes, wash with plenty of water and consult a doctor.

#### ■ When not using your camcorder for a long time

- Turn on the camcorder and record and play back images about once a month to keep it in an optimum state for a long time.
- Use up the battery pack completely before storing it.

#### Moisture condensation

If your camcorder is brought directly from a cold place to a warm place, moisture may condense inside your camcorder and cause a malfunction of your camcorder.

#### ■ If moisture condensation has occurred

Leave your camcorder for about 1 hour without turning it on.

#### ■ Note on moisture condensation

Moisture may condense when you bring your camcorder from a cold place into a warm place (or vice versa) or when you use your camcorder in a humid place as shown below.

- When you bring your camcorder from a ski slope into a place warmed up by a heating device.
- When you bring your camcorder from an air conditioned car or room into a hot place outside.
- When you use your camcorder after a squall or a shower.
- When you use your camcorder in a hot and humid place.

## ■ How to avoid moisture condensation

When you bring your camcorder from a cold place into a warm place, put your camcorder in a plastic bag and seal it tightly. Remove the bag when the air temperature inside the plastic bag has reached the ambient temperature (after about 1 hour).

## LCD screen

- Do not exert excessive pressure on the LCD screen, as it may cause damage.
- If your camcorder is used in a cold place, a residual image may appear on the LCD screen. This is not a malfunction.
- While using your camcorder, the back of the LCD screen may heat up. This is not a malfunction.

## ■ To clean the LCD screen

The LCD screen is covered with a coating. The coating may be peeled off by scratching or rubbing. Maintain the LCD screen as follows.

- Wipe fingerprints or hand cream off the LCD screen as soon as possible, as they may cause the coating to peel off.
- If you rub the LCD screen hard, even with a tissue, the coating may be damaged.
- Before wiping the LCD screen, blow dust or sand off with a dust blower, etc.
- Wipe dirt off the LCD screen with a clean, soft cloth, such as an eye glass cleaning cloth, etc.

## ■ To adjust the touch panel (CALIBRATION)

The buttons on the touch panel may not work correctly. If this happens, follow the procedure below. It is recommended that you connect your camcorder to the wall outlet (wall socket) using the supplied AC Adaptor during the operation.

- ① Press the MENU button → select  (OTHERS) → [CALIBRATION] with the ▲/▼/◀/▶/EXEC button.
- ② Touch “x” displayed on the LCD screen with the corner of memory card or the like 3 times.



## ⓘ Notes

- If you did not press the right spot, try the calibration again.
- Do not use a sharp-pointed object for calibration. Doing so may damage the LCD screen.
- You cannot perform the calibration when the LCD screen is turned around, or facing up and closed to the camcorder

## ■ OLED panel display

The OLED panel may experience issues such as screen burn-in or loss of brightness with normal use over time. This is not a malfunction.

## Casing

- If the casing is soiled, clean the camcorder body with a soft cloth lightly moistened with water, and then wipe the casing with a dry soft cloth.
- Avoid the following to prevent damage to the finish.
  - Using chemicals such as thinner, benzene, alcohol, chemical cloths, repellent, insecticide and sunscreen.
  - Handling with above substances on your hands.
  - Leaving the casing in contact with rubber or vinyl objects for a long period of time.

## Care and storage of the lens

- Wipe the surface of the lens clean with a soft cloth in the following instances:
  - When there are fingerprints on the lens surface.
  - In hot or humid locations
  - When the lens is exposed to salty air such as at the seaside.
- Store in a well-ventilated location subject to little dirt or dust.
- To prevent mold, periodically clean the lens as described above.

### Charging the pre-installed rechargeable battery

Your camcorder has a pre-installed rechargeable battery to retain the date, time, and other settings even when the POWER switch is set to OFF. The pre-installed rechargeable battery is always charged while your camcorder is connected to the wall outlet (wall socket) via the AC Adaptor or while the battery pack is attached. The rechargeable battery will be fully discharged in about **3 months** if you do not use your camcorder at all without the AC Adaptor connected or the battery pack attached. Use your camcorder after charging the pre-installed rechargeable battery.

However, even if the pre-installed rechargeable battery is not charged, the camcorder operation will not be affected as long as you are not recording the date.

#### ■ Procedures

Connect your camcorder to a wall outlet (wall socket) using the supplied AC Adaptor, and leave it with the power turned off for more than 24 hours.

### Note on disposal/transfer of the memory card

Even if you delete data in the memory card or format the memory card on your camcorder or a computer, you may not delete data from the memory card completely. When you give the memory card to somebody, it is recommended that you delete data completely using data deletion software on a computer. Also, when you dispose of the memory card, it is recommended that you destroy the actual body of the memory card.

Operation is not guaranteed when using a card adaptor.



# Specifications

## System

### Video signal

When [60i] is selected:  
NTSC color, EIA standards  
HDTV 1080/60i, 1080/60p, 720/60p  
When [50i] is selected:  
PAL color, CCIR standards  
HDTV 1080/50i, 1080/50p, 720/50p

### Video recording system

XAVC HD : MPEG-4 AVC/H.264  
4:2:2 Long profile  
AVCHD : MPEG-4 AVC/H.264  
AVCHD 2.0 format compatible  
SD image quality: DV standard  
compatible

### Audio recording system\*

XAVC HD : Linear PCM 2ch, 24bit,  
48kHz  
AVCHD : Linear PCM 2ch, 16bit,  
48kHz / Dolby Digital 2ch, 16bit,  
48kHz  
DV : Linear PCM 2ch, 16bit, 48kHz

### Recording media (movies)

Memory Stick Pro Duo™ and SD card

### Image device

1.0 type Exmor R CMOS sensor  
Gross : Approx. 20 900 000 pixels  
Effective (movie, 16:9 mode):  
Approx. 14 200 000 pixels  
Effective (movie, 4:3 mode):  
Approx. 10 600 000 pixels

### Lens

Lens Mount: Fixed  
Zoom Ratio: 12x (optical), servo  
Focal Length: f=9.3 - 111.6mm  
equivalent to f=29.0 - 348.0mm on  
35 mm lens(16:9)  
equivalent to f=35.5 - 426.0mm on  
35mm lens(4:3)  
Iris: F2.8 - F4.5  
auto/manual selectable  
Focus: AF/MF selectable, 10 mm to ∞  
(Wide), 1000 mm to ∞ (Tele)

Image Stabilizer: ON/OFF selectable,  
shift lens

Filter Diameter: M62 mm

### Color temperature

Preset (Indoor:3200K,  
Outdoor:5600K±7 steps, Color  
temperature set range:2300-15000K),  
Onepush A, B, Auto selectable

### Minimum illumination

60i 3lux(1/60 Shutter Speed, iris/gain  
AUTO) 50i 3lux (1/50 Shutter Speed,  
iris/gain AUTO)  
60i 1.7lux(1/30 Shutter Speed, iris/gain  
AUTO) 50i 1.7lux(1/25 Shutter Speed,  
iris/gain AUTO)

## Input/output connectors

### VIDEO OUT jack

Integrated into Multi/Micro USB jack  
(x1), Composite  
1.0 Vp-p, 75 Ω

### AUDIO OUT jacks

Integrated into Multi/Micro USB jack

### HDMI OUT jack

Type A (x1)

### SDI OUT jack

BNC jack (x1)

### USB jack

Multi/Micro USB jack (x1)

### Ⓜ (headphones) jack

Stereo mini jack (x1)

### INPUT1/INPUT2 jacks

XLR-type 3-pin (female) (x2), line/mic/  
mic +48 V selectable

### MIC jack (PLUG INPOWER) (x1)

### Multi Interface Shoe (x1)

## Screen

### LCD screen

8.8 cm (3.5 type)  
Approx. 1.56M dots.

### Viewfinder

1.0 cm (0.39 type) OLED  
Approx. 1.44M dots

## Specifications (Continued)

### General

#### Power requirements

DC 6.8 V / 7.2 V (battery pack)  
DC 8.4 V (AC Adaptor)

#### Average power consumption\*

During camera recording using the viewfinder with normal brightness.  
Approx. 5.5 W  
During camera recording using the LCD with normal brightness.  
Approx. 5.8 W

#### Operating temperature

0 °C to 40 °C (32 °F to 104 °F)

#### Storage temperature

-20 °C to +60 °C (-4 °F to +140 °F)

#### Dimensions (approx.)

Camcorder body only (including the projecting parts):  
120.7 mm × 103.5 mm × 274.3 mm  
(4 7/8 in. × 4 1/8 in. × 10 7/8 in.) (w/h/d) (With the accessories (lens hood, large eyecup), excluding the grip belt and including the projecting parts)  
130.3 mm × 180.9 mm × 287 mm  
(5 1/4 in. × 7 1/8 in. × 11 3/8 in.) (w/h/d) (With the accessories (lens hood, large eyecup, XLR handle unit), excluding the grip belt and including the projecting parts)  
130.3 mm × 180.9 mm × 287 mm  
(5 1/4 in. × 7 1/8 in. × 11 3/8 in.) (w/h/d) (With the accessories (lens hood, large eyecup, grip belt (excluding the belt) attached.))

#### Mass (approx.)

945 g (2 lb 1 oz) (with accessories (lens hood and large eyecup))  
1400 g (3 lb 1 oz) (with accessories (lens hood, large eyecup, battery (NP-FV70)), and XLR handle unit)

### Rechargeable battery pack NP-FV70

Maximum output voltage: DC 8.4 V  
Output voltage: DC 6.8 V  
Capacity:  
Typical: 14.0 Wh (2 060 mAh)  
Minimum: 13.3 Wh (1 960 mAh)  
Type: Li-ion

### AC Adaptor AC-L200D

#### Power requirements

AC 100 V - 240 V, 50 Hz/60 Hz

#### Power consumption

18 W

#### Output voltage

DC 8.4 V\*1

#### Operating temperature

0 °C to 40 °C (32 °F to 104 °F)

#### Storage temperature

-20 °C to +60 °C (-4 °F to +140 °F)

#### Dimensions (approx.)

48 mm × 29 mm × 81 mm  
(1 15/16 in. × 1 3/16 in. × 3 1/4 in.)  
(w/h/d) excluding the projecting parts

#### Mass (approx.)

170 g (6.0 oz) excluding the power cord  
(mains lead)

\*1 See the label on the AC Adaptor for other specifications.

### Wireless LAN

#### Supported standard

IEEE 802.11 b/g/n

#### Frequency

2.4 GHz

#### Supported security protocols

WEP/WPA-PSK/WPA2-PSK

#### NFC

NFC Forum Type 3 Tag compliant

Design and specifications of your camcorder and accessories are subject to change without notice.

• Manufactured under license from Dolby Laboratories.

## On trademarks

- “XDCAM” logo is a trademark of Sony Corporation.
- “XAVC” and **XAVC** are the registered trademarks of Sony Corporation.
- “AVCHD Progressive” and “AVCHD Progressive” logotype are trademarks of Panasonic Corporation and Sony Corporation.
- “Memory Stick,”  “Memory Stick Duo,” **MEMORY STICK DUO**,” “Memory Stick PRO Duo,” **MEMORY STICK PRO DUO**,” “Memory Stick PRO-HG Duo,” **MEMORY STICK PRO-HG DUO**,” “Memory Stick XC-HG Duo,” **MEMORY STICK XC-HG DUO**,” “MagicGate,” **MAGIC GATE**,” “MagicGate Memory Stick,” “MagicGate Memory Stick Duo” “Content Browser Mobile” and “Content Browser Mobile” logo are trademarks of Sony Corporation.
- “InfoLITHIUM” is a trademark of Sony Corporation.
- “BRAVIA” is a trademark of Sony Corporation.
- Blu-ray Disc™ and Blu-ray™ are trademarks of the Blu-ray Disc Association.
- Dolby and the double-D symbol are trademarks of Dolby Laboratories.
- Microsoft, Windows, and Windows Vista are trademarks or registered trademarks of U.S. Microsoft Corporation in the U.S. and other countries.
- Mac and Mac OS are registered trademarks of Apple Inc. in the U.S. and other countries.
- iPhone and iPad are trademarks of Apple Inc., registered in the U.S. and other countries.
- iOS is a registered trademark or trademark of Cisco Systems, Inc. and/or its affiliates in the United States and certain other countries
- The terms HDMI and HDMI High-Definition Multimedia Interface, and the HDMI Logo are trademarks or registered trademarks of HDMI Licensing LLC in the United States and other countries.
- Intel, Pentium, and Intel Core are registered trademarks or trademarks of Intel Corporation in the United States and other countries.
- Android, Google Play are trademarks of Google Inc.
- Wi-Fi, the Wi-Fi logo, Wi-Fi PROTECTED SET-UP are registered trademarks of the Wi-Fi Alliance.
- The N Mark is a trademark or registered trademark of NFC Forum, Inc. in the United States and in other countries.
- Adobe, the Adobe logo, and Adobe Acrobat are either registered trademarks or trademarks of Adobe Systems Incorporated in the United States and/or other countries.
- SDXC logo is a trademark of SD-3C, LLC.

All other product names mentioned herein may be the trademarks or registered trademarks of their respective companies. Furthermore, ™ and “®” are not mentioned in each case in this manual.

## Specifications (Continued)

### Notes on the License

ANY USE OF THIS PRODUCT OTHER THAN CONSUMER PERSONAL USE IN ANY MANNER THAT COMPLIES WITH THE MPEG-2 STANDARD FOR ENCODING VIDEO INFORMATION FOR PACKAGED MEDIA IS EXPRESSLY PROHIBITED WITHOUT A LICENSE UNDER APPLICABLE PATENTS IN THE MPEG-2 PATENT PORTFOLIO, WHICH LICENSE IS AVAILABLE FROM MPEG LA, L.L.C., 250 STEELE STREET, SUITE 300, DENVER, COLORADO 80206.

THIS PRODUCT IS LICENSED UNDER THE AVC PATENT PORTFOLIO LICENSE FOR THE PERSONAL USE OF A CONSUMER OR OTHER USES IN WHICH IT DOES NOT RECEIVE REMUNERATION TO

(i) ENCODE VIDEO IN COMPLIANCE WITH THE AVC STANDARD (“AVC VIDEO”) AND /OR

(ii) DECODE AVC VIDEO THAT WAS ENCODED BY A CONSUMER ENGAGED IN A PERSONAL ACTIVITY AND/OR WAS OBTAINED FROM A VIDEO PROVIDER LICENSED TO PROVIDE AVC VIDEO.

NO LICENSE IS GRANTED OR SHALL BE IMPLIED FOR ANY OTHER USE.

ADDITIONAL INFORMATION MAY BE OBTAINED FROM MPEG LA, L.L.C.

SEE <[HTTP://WWW.MPEGLA.COM](http://WWW.MPEGLA.COM)>

Software is installed in your camcorder. We provide this software based on the license agreements of the copyright owners. Based on requests by the owners of copyright of these software applications, we have an obligation to inform you of the following.

Licenses (in English) are recorded in the internal memory of your camera. Establish a Mass Storage connection between the camera and a computer to read licenses in the “PMHOME” - “LICENSE” folder.

### On GNU GPL/LGPL applied software

The software that is eligible for the following GNU General Public License (hereinafter referred to as “GPL”) or GNU Lesser General Public License (hereinafter referred to as “LGPL”) are included in the camcorder.

This informs you that you have a right to have access to, modify, and redistribute source code for these software programs under the conditions of the supplied GPL/LGPL.

Source code is provided on the web. Use the following URL to download it. When downloading the source code, select PXW-X70 as the model for your camcorder.

<http://www.sony.net/Products/Linux/>

We would prefer you do not contact us about the contents of source code.

Licenses (in English) are recorded in the internal memory of your camera. Establish a Mass Storage connection between the camera and a computer to read licenses in the “PMHOME” - “LICENSE” folder.

# Index

## A

AC Adaptor.....	21
Accessory shoe.....	23
Accessory shoe plate.....	23
AE SHIFT.....	87, 107
AGC LIMIT.....	86
AIRPLANE MODE.....	99
AREA SET.....	100
ASPECT.....	94
ASSIGN BUTTON.....	64
AUDIO LEVEL DISPLAY .....	95
AUDIO SET menu.....	92
AUTO BACK LIGHT.....	88
AUTO MODE SET.....	47
AUTO SLOW SHUTTER.....	88
AVCHD AUDIO FORMAT .....	92

## B

Battery.....	21
BEEP.....	101
BLACK GAMMA.....	55
BLACK LEVEL.....	55
Button-type lithium battery .....	12

## C

CALIBRATION.....	123
CAMERA DATA DISPLAY .....	95
CAMERA PROFILE.....	100
CAMERA SET menu.....	86
CENTER.....	94
Charging time.....	21
CHG lamp.....	21
CLOCK SET.....	24
COLOR BAR.....	89, 107
COLOR DEPTH.....	57
COLOR MODE.....	56
COLOR PHASE.....	57

## Connect

Recorder.....	103
TV.....	73
CTRL W/SMARTPHONE .....	50

## D

D.EXTENDER.....	87
DATA CODE.....	71, 96
Date and time.....	14, 25
DATE REC.....	101
DELETE.....	77
DETAIL.....	59
DISP MAC ADDRESS.....	99
DISPLAY OUTPUT.....	97
DISPLAY SET menu.....	93
DIVIDE.....	76
DOWN CONVERT TYPE .....	91
DV MODE.....	38
DV WIDE CONVERT.....	91
DV WIDE REC.....	90

## E

EDIT DEVICE NAME.....	99
-----------------------	----

## F

FACE DETECTION.....	35
Focus.....	34
FOCUS DISPLAY.....	96
FOCUS MAG RATIO.....	95
Focus Magnifier.....	35
FREE RUN.....	98

## G

Gain.....	40
GAMMA.....	55
GUIDEFAME.....	95

## H

Handle record button.....	32
---------------------------	----

Handle zoom.....	33
Handle zoom lever.....	33
Handle zoom switch.....	33
HDMI.....	90
HDMI TC OUTPUT.....	91
HISTOGRAM.....	93

## I

Image database file.....	80
“InfoLITHIUM” battery pack .....	120
INITIALIZE.....	102
IRIS.....	39
Items.....	83

## K

KNEE.....	56
-----------	----

## L

LANGUAGE.....	101
Large eyecup.....	26
Last Scene Review.....	63
LCD BRIGHT.....	96
Lens.....	8, 123

## M

MARKER.....	94, 107
MEDIA FORMAT.....	78
Memory card.....	27, 119
“Memory Stick” media .....	120
“Memory Stick PRO Duo” media.....	120
Menu.....	83
AUDIO SET menu.....	92
CAMERA SET menu.....	86
DISPLAY SET menu .....	93
Items.....	83
NETWORK SET menu .....	99
OTHERS menu.....	100

## Index (Continued)

- REC/OUT SET menu.....90  
TC/UB SET menu.....97  
Using .....81
- Moisture condensation ..... 122
- Movie.....29
- Multi Interface Shoe.....4
- Multi/Micro USB jack.....4
- ### N
- ND filter .....41
- NETWORK SET menu .....99
- NFC .....49
- NIGHTSHOT LIGHT .....89
- ### O
- OPERATION TIME..... 102
- OTHERS menu..... 100
- Output resolution.....74
- Outside power source .....21
- ### P
- PEAKING .....94, 107
- PICTURE PROFILE.....53, 89
- Playback .....66
- Power zoom lever.....33
- Pre-installed rechargeable battery ..... 124
- PROTECT .....76
- ### R
- REC BUTTON SET.....32
- REC FORMAT.....37
- REC LAMP.....101
- REC RUN.....98
- REC SET.....90
- REC/OUT SET menu.....90
- Record button .....32
- Recording .....29
- Recording format.....37
- Recording time ..... 114
- Relay recording .....31
- REMOTE CONTROL..... 101
- REPAIR IMAGE DB FILE ..... 80
- ### S
- S&Q MOTION ..... 62
- SAFETY ZONE..... 94
- SCENE SELECTION SET ..... 47
- Screen indicators ..... 13
- SDI OUT ..... 73
- Self-diagnosis display ..... 111
- SHUTTER DISPLAY..... 96
- Shutter speed.....40
- SIMUL/RELAY REC ..... 31
- Simultaneous recording ..... 31
- Slow & Quick Motion..... 61
- Specifications..... 125
- SPOT FOCUS..... 35
- SPOT METER ..... 88
- SPOT METER/FOCUS ..... 88
- SSID/PW RESET ..... 99
- STATUS CHECK..... 72, 100
- STEADY SHOT ..... 88
- SUMMERTIME ..... 101
- Supplied accessories ..... 19
- ### T
- TC FORMAT..... 97
- TC MAKE..... 98
- TC PRESET ..... 60, 107
- TC RUN..... 98
- TC/UB DISPLAY..... 97
- TC/UB SET menu..... 97
- Telephoto ..... 33
- TONE..... 89
- Trademark ..... 127
- Transmitter..... 12
- Troubleshooting..... 104
- TV ..... 73
- ### U
- UB PRESET ..... 60
- UB TIME REC..... 98
- USB CONNECT ..... 102
- USB LUN SET..... 102
- Using your camcorder abroad ..... 116
- ### V
- VERSION DISPLAY ..... 102
- VF BRIGHT ..... 85
- VF COLOR TEMP..... 97
- VIDEO OUT ..... 90
- Viewfinder..... 26
- VOLUME..... 68, 92
- ### W
- Warning indicators ..... 111
- WB OUTDOOR LEVEL ..... 86
- WB PRESET ..... 86
- WB SHIFT ..... 58
- WB TEMP SET..... 86
- White balance ..... 42
- Wide angle..... 33
- Wi-Fi ..... 48
- Wireless Remote Commander ..... 12
- ### Z
- ZEBRA ..... 94, 107
- Zoom ..... 33
- ZOOM DISPLAY ..... 96
- ZOOM SET ..... 87
- ### Numeric
- 60i/50i SEL ..... 101



<http://www.sony.net/>

© 2014 Sony Corporation

Printed in China

